

Operating Manual

High Temperature Circulator HT60-M2 HT60-M3 C.U.-cooling unit

Distributed by:



Carl Stuart Limited

ADVANCED APPLIED TECHNOLOGIES

Contact Us:

Irl Ph: 01 4523432

UK Ph: 08452 30 40 30

Web: www.carlstuart.com

Email: info@carlstuart.com

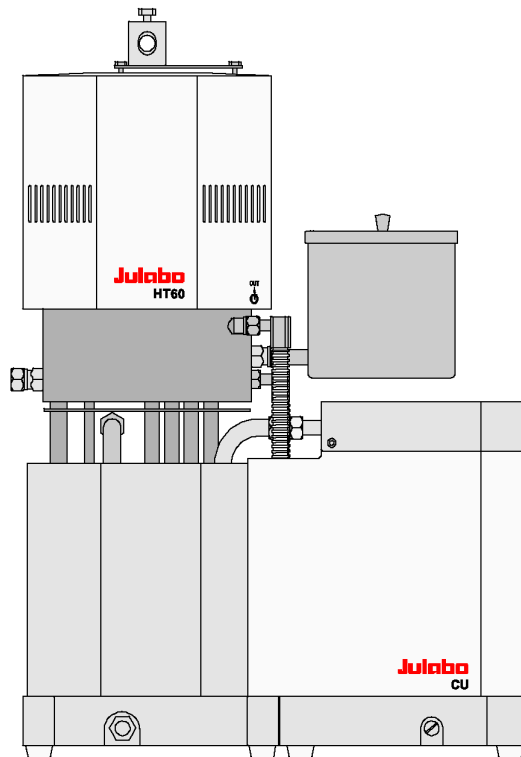
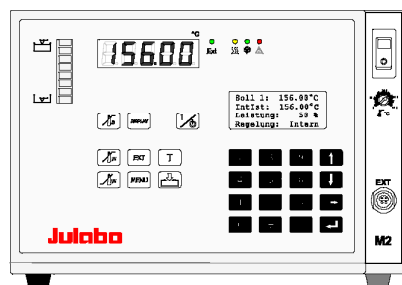

Julabo
Innovative Temperature Technology

Version: V 4.01-J

Printed in Germany
Changes without prior notification reserved
1.951.3727 BE5 06/07

JULABO Labortechnik GmbH
77960 Seelbach / Germany

+49 (0) 7823 / 51-0

+49 (0) 7823 / 24 91

info@julabo.de

www.julabo.de

Congratulations!

You have made an excellent choice.

JULABO thanks you for the trust you have placed in us.

This operating manual has been designed to help you to gain an understanding of the principles of operating and possibilities of our circulators. For optimum utilization of all functions, we recommend you to thoroughly study this manual prior to beginning operation.

Safety Warnings

Take care your unit is operated only by qualified persons.

Make sure you read and understand all instructions and safety precautions listed in this manual before installing or operating your unit. If you have any questions concerning the operation of your unit or the information in this manual, contact JULABO.

Performance of installation, operation, or maintenance procedures other than those described in this manual may result in a hazardous situation and may void the manufacturer's warranty.

Transport the unit with care.

Sudden jolts or drops may cause damages in the interior of the unit.

Observe all warning labels.

Never remove warning labels.

Never operate damaged or leaking equipment.

Never operate the unit without bath fluid in the bath.

Empty the unit before moving it.

Always turn off the unit and disconnect the mains cable from the power source before performing any service or maintenance procedures, or before moving the unit.

Never operate equipment with damaged mains power cables.

Refer service and repairs to a qualified technician.





	<p>In addition to the safety warnings listed above, warnings are posted throughout the manual. These warnings are designated by an exclamation mark inside an equilateral triangle. „Warning of a dangerous situation (Attention ! Please follow the documentation).“</p> <p>The danger is described according to an alarm keyword.</p> <p>Read and follow these important instructions.</p>
	<p>Warning:</p> <p>Describes a possibly highly dangerous situation. If this is not avoided, serious injury and danger to life could result.</p>
	<p>Caution:</p> <p>Describes a possibly dangerous situation. If this is not avoided, slight or minor injuries could result. A warning of possible damage can also be contained in the text.</p>
	<p>Notice:</p> <p>Describes a possibly harmful situation. If this is not avoided, the product or anything in its surroundings can be damaged.</p>







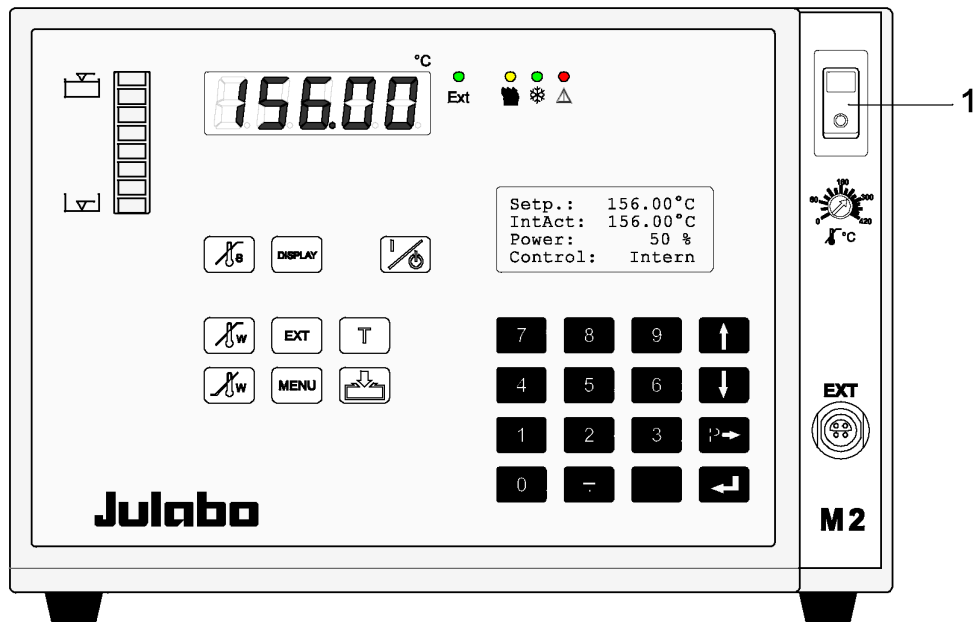

TABLE OF CONTENTS

1. OPERATING CONTROLS AND FUNCTIONAL ELEMENTS	4
M2 or M3 – control electronic	4
HT60 High Temperature Circulator with C.U.-cooling unit (option).....	7
2. DESCRIPTION.....	9
3. JULABO QUALITY SYSTEM	10
4. UNPACKING AND CHECKING.....	10
5. PREPARATIONS	10
5.1. Setup	10
5.2. Installation	11
5.3. Bath liquids.....	13
5.4. Tubing	14
5.5. Power connection	15
5.6. Filling / draining	16
5.7. Degasifying.....	18
5.8. Countercooling	20
6. OPERATING PROCEDURES.....	21
6.1. Switching on / Selecting the language.....	21
7. MANUAL OPERATION	22
7.1. Start - Stop	22
7.2. Setting the temperatures	22
7.3. Warning functions.....	23
7.4. Setting the safety temperature (with shutdown function).....	24
7.5. Internal / external control	25
8. MENU FUNCTIONS.....	26
8.1. Configuration	27
8.2. Control parameters.....	30
8.3. Start of a profile	33
8.3.1. Interrupting a profile	35
8.4. Integrated programmer.....	36
8.5. Analog inputs/outputs.....	39
8.6. Limits	42
8.7. Interface	43
8.8. Sensors	43
9. TROUBLESHOOTING GUIDE / ERROR MESSAGES	45
10. SAFETY RECOMMENDATIONS	47
11. ELECTRICAL CONNECTIONS.....	48
12. REMOTE CONTROL	51
12.1. Setup for remote control.....	51
12.2. Communication with a PC or a superordinated data system	51
12.3. List of commands	53
12.4. Status messages / error messages	56
13. CLEANING THE UNIT	57
14. RESPONSIBILITY OF THE OPERATOR.....	58
15. MAINTENANCE	58
16. TECHNICAL SPECIFICATIONS	59
17. EC DECLARATION OF CONFORMITY	61
18. WARRANTY CONDITIONS	62

1. Operating controls and functional elements



M2 or M3 – control electronic







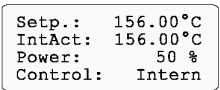

- | | | |
|---|---|---|
| 1 | | Mains power switch, illuminated |
| 2 |  | Start / stop key |
| 3 |  | Working temperature T |
| 4 |  | Key for automatic filling and aeration |
| 5 |  | High temperature warning limit |
| 6 |  | Low temperature warning limit |
| 7 |  | Safety temperature |
| 8 |  | Adjustable excess temperature protection (safety temperature) |
| 9 |  | Control type: internal/external control |

10  MULTI-DISPLAY (LED) temperature indication

11  Display of internal/external actual value

Ext Indicator lights:
 Temperature indication - external actual value
 /  /  Alarm / Cooling / Heating

12  DIALOG-DISPLAY (LCD) for indication of:
 Line 1: Setpoint  or  or 
 Line 2: Internal or external actual value 
 Line 3: Heating power in %
 Line 4: Control type: internal /  external control

13  MENUE key - for selecting the menu functions

14   Cursor keys - Select menu items

15  P-key Selecting parameters

16    Numeral keypad: numerals 0 to 9; minus / decimal point

17  Enter key 1) Store value / parameter
 2) Next lower menu level

18  Escape key 1) Cancel entries
 2) Return to a higher menu level

19  EXT Socket for external measurement and control sensor Pt100

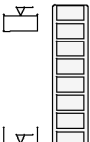
20  8-grade liquid level indication

Operating controls and functional elements

Rear view

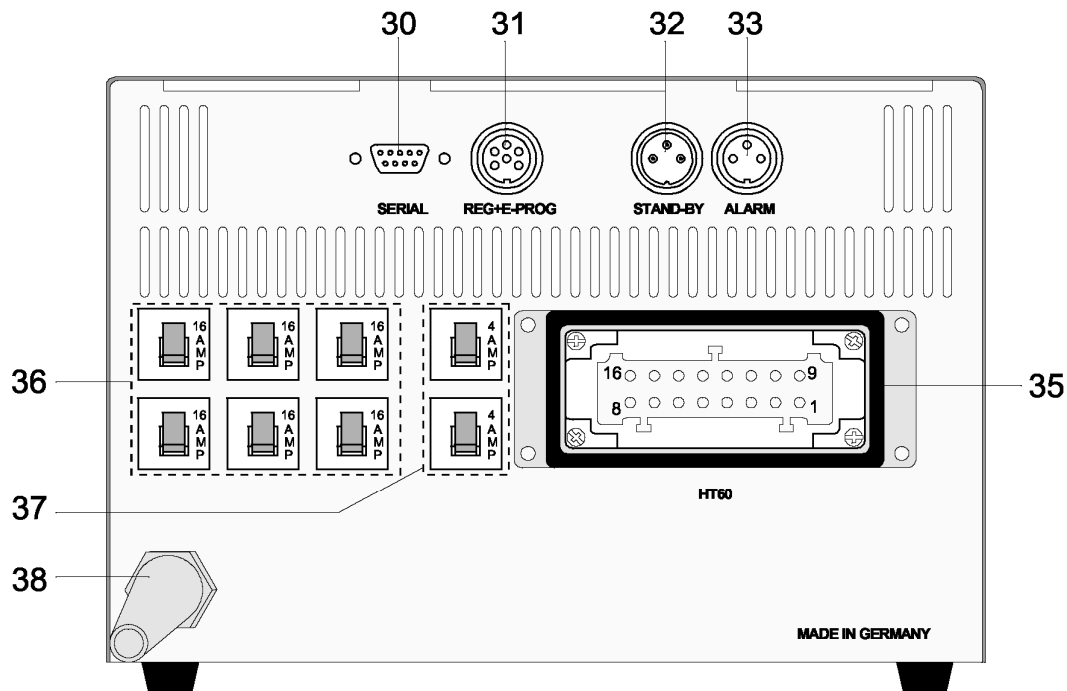



30  SERIAL Interface RS232/RS485

31  REG+E-PROG Programmer input and temperature recorder output

32  STAND-BY Stand-by input (for external emergency switch-off)

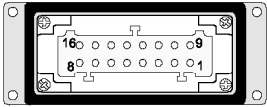
33  ALARM Alarm output (for external alarm signal)

35  Control exit Connector for control cable of circulator HT60

36   M2 – Mains circuit breakers (resettable): 3x Mains fuses 16 A, or
M2 – 3x fuse holder with fein-wire fuses T16A, 5x20 mm
M3 – Mains circuit breakers (resettable): 6x Mains fuses 16 A,

37  Mains circuit breakers (resettable): Fuses 4 A, for C.U.-cooling unit

38 Mains power cable with plug

HT60 High Temperature Circulator with C.U.-cooling unit (option)

Front view:

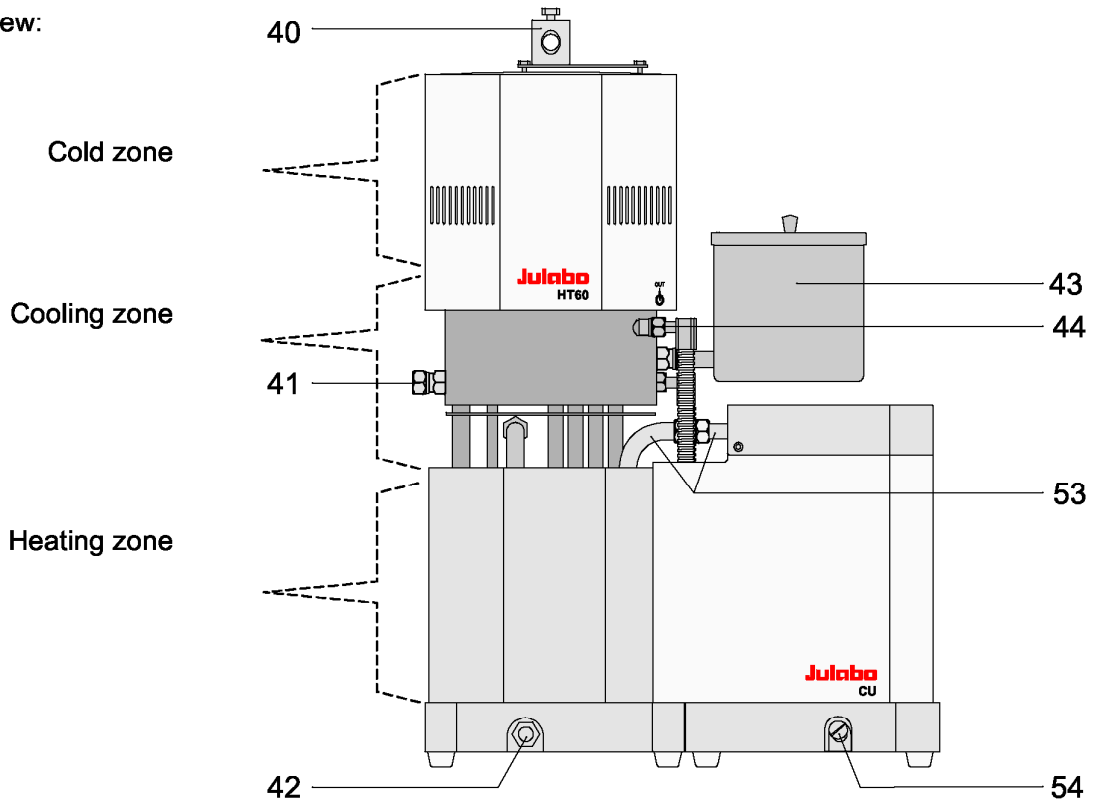

Rear view:

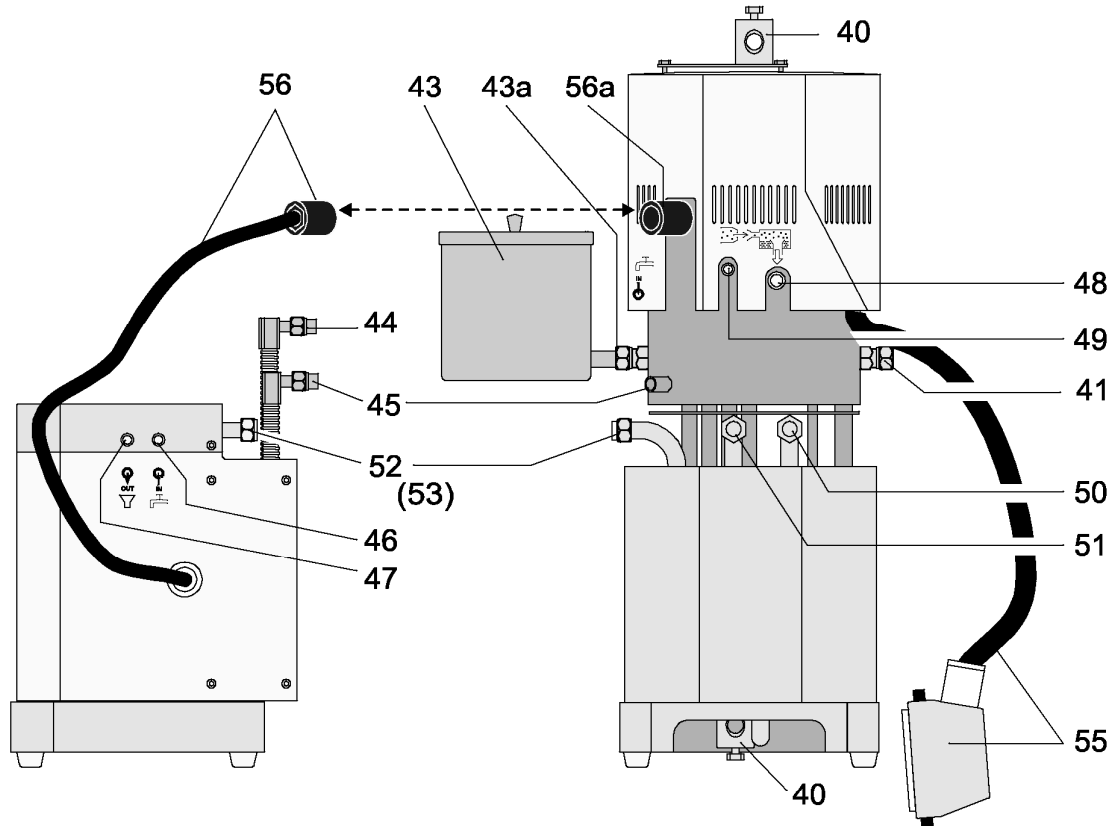





Presentation: Cooling unit

divided from

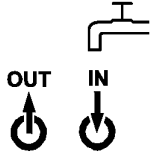
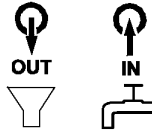
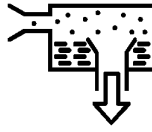
HT60

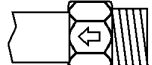
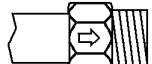
Operating controls and functional elements

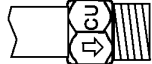
40		Stand rod attachment with mouting screw; $\varnothing 12$; M8
41		Connector for liquid level indicator or second expansion vessel; M16x1 / $\angle 37^\circ$
42		Drain plug for bath liquid; M16x1
43/43a		Expansion vessel / Connector for expansion vessel; M16x1 (When filling it serves as funnel)
44/45		<p>Cooling water connectors at the HT60, M12 / $\angle 37^\circ$ OUT – outlet (44), IN – inlet (45)</p> <ul style="list-style-type: none"> • Connection for cooling water or • Connection for clocked cooling water with magnetic valve or • Connection for clocked cooling water out of the C.U.-cooling unit
46/47		<p>Cooling water connectors at the C.U.-cooling unit; $\varnothing 10$ IN –inlet, OUT – outlet</p>
48		<p>Overflow connector $\varnothing 15,5$ / G $\frac{1}{4}$" Internal thread</p>
49		<p>Inert gas connector $\varnothing 10$; M8x1 Internal thread</p>
50		<p>Pump connector for external temperatur application Return; M16x1</p>
51		<p>Pump connector for external temperatur application Feed ; M16x1</p>
52		<p>Pump connector for C.U.-cooling unit - Return; M16x1 (Cooling circuit)</p>
53		<p>Pump connector for C.U.-cooling unit - Feed; M16x1 (Cooling circuit)</p>
54		Drain plug for cooling water; M10x1
55		Control cable with 16-channel plug for connection of the M2 or M3 control electronics
56		Control cable with 6-channel plug for connection of the C.U.-cooling unit
56a		Control exit for C.U.-cooling unit
56a		or Control exit for magnetic valve (for clocked cooling water)



Danger sign: Hot surface ! Attention ! Do not touch.

2. Description

The High Temperature Circulators HT60-M2 and HT60-M3 are to be employed especially for closed tempering circuits in the laboratory, the technical institution or the production, like e.g. for distillation plants, reaction vessels, autoclaves, injection moulding tools.

The structure of the **High Temperature Circulator HT60** is sub-divided in three zones:

- The cold zone (on top) with the electronics for controlling and monitoring, the temperature control and the pump motor.
- The cooling zone with the cooling coil, the float for the level indication, a temperature sensor for monitoring the temperature, the connection for inert-gas, the connection for the expansion vessel as well as an overflow nozzle. At this place the temperature monitoring is independent from the other safety devices.
- The heating element (down) with the heating element, the pump, the temperature sensors and the flow nozzle.

The **C.U.-cooling unit** can be installed firmly and fulfills two tasks.

- The temperature of the tempering liquid in the cooling zone is supervised. If it is necessary the cooling water is led through the integrated cooling coil in order to reduce the temperature (without C.U.-cooling unit the cooling coil can be connected directly to the cooling water).
- With a separate cooling circuit through the C.U.-cooling unit a rapid cooling of the tempering liquid becomes possible.

The **M2 or M3 control electronics** is connected to the HT60-circulator via a control cable.

- The local operation of the control electronics M2 / M3 is effected via a splash-water protected keypad. The Microprocessor technology allows to set three different temperature values, to store and to indicate them via the dialogical display LCD – the working temperature and the values for the excess and lower temperature warning functions.
- With the integrated programmer the instructions for setpoint and time for six different temperature profiles can be stored and called in.
- Via an analogical interface REG+E-PROG an analogical programmer can be connected for the setpoint.

At the same time this interface is provided with three analogical exits for the recorder. For the best resolution the exit sizes can be adjusted via the menu-surface.

- The remote control via the digital RS232/RS485 interface according to NAMUR allows the most modern process technology without additional interface.
- The excess temperature protection according to DIN 12876-1-2000 is a safety equipment which does not depend on the control circle. Its safety value is shown and can be adjusted by the MULTI-DISPLAY (LED).
- The level of liquid is acquired in the cooling zone, indicated to the control electronics via the control cable. There they are made visible by an 8-grade level indication.

3. JULABO Quality System



The JULABO Quality Management System:

Development, production and distribution of temperature application instruments for research and industries conform to the requirements according to DIN EN ISO 9001:2000.

Certificate Registration No. 01 100044846

4. Unpacking and checking

Unpack the high temperature circulator and accessories and check for damages incurred during transit. These should be reported to the responsible carrier, railway, or postal authority, and a request for a damage report should be made. These instructions must be followed fully for us to guarantee our full support of your claim for protecting against loss from concealed damage. The form required for filing such a claim will be provided by the carrier.

5. Preparations

5.1. Setup

**High temperature circulator HT60 as well as
High temperature circulator HT60 with CU cooling unit:**

as a desktop unit

- Place the circulator on an even surface on a pad made of **non-inflammable** material.

as a stand-mounted unit

- Place the unit in an vertical position.
- A wall distance of at least 15 cm must be maintained for ventilation, allowing internal heat to be conducted away from the unit.

Also see chapter 58

JULABO Order-No. 9790100 CU cooling unit

M2 or M3 remote control electronics:

- The unit should be set up at a dry location.
- Place the unit in an upright position and do not obstruct the ventilation Ambient temperatures above 40 °C result in a failure of the unit.
- Do not set up the unit in the immediate vicinity of heat sources and do not expose to sun light.

5.2. Installation



Attention:

The C.U.-cooling unit or the magnetic valve always have to be connected in absence of current.



- CoolingMax –

With the C.U.-cooling unit or the magnetic valve the menupoint CoolingMax has to be adjusted to a value of > 0 (Recommendation: 100%). So the automatical control of the cooling can become active (see 8.6. Limits).

Installation of the C.U.-unit

JULABO Order-No. 9790100 C.U. cooling unit

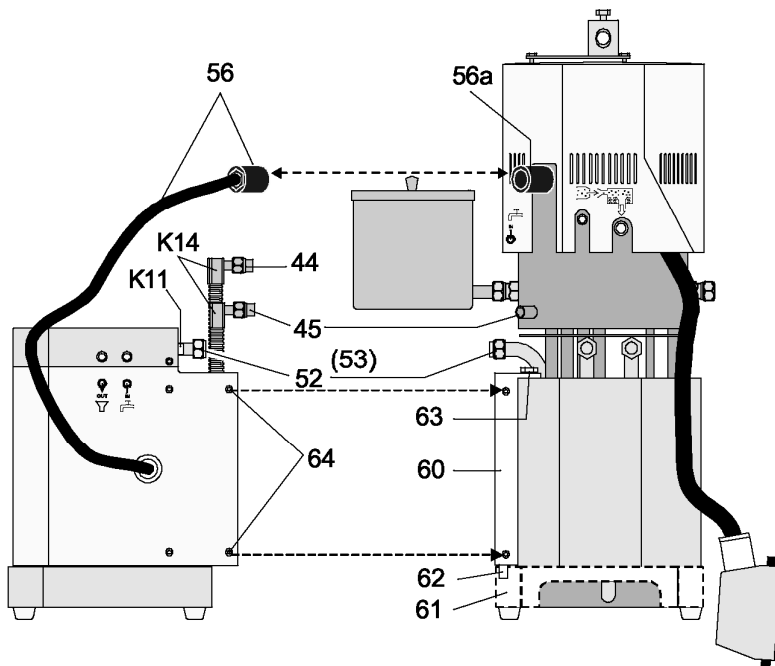

- Use the leader pins (62) to fix the assembly sheet (60) into the base (61) of the circulator and fasten with hexagon screws (63).
- Push the C.U.-cooling unit to the circulator and screw it tightly at the points (64).
- Connect the cooling circulation for the oil (52, 53) (open end wrench SW19). When doing this hold the tube at position K11 with an open end wrench SW21.

- Connect the cooling water (44, 45) (open end wrench SW15) When doing this hold the tube at position (K14) with an open end wrench (SW14)
- Fix the control cable (56) at the control exit (56a) and screw it tightly.

Cooling capacity at 2 l/min flow of cooling water.

Temperature <IntAct>	[°C]	350	250	150	75
Cooling capacity	[kW]	12	8	4	1

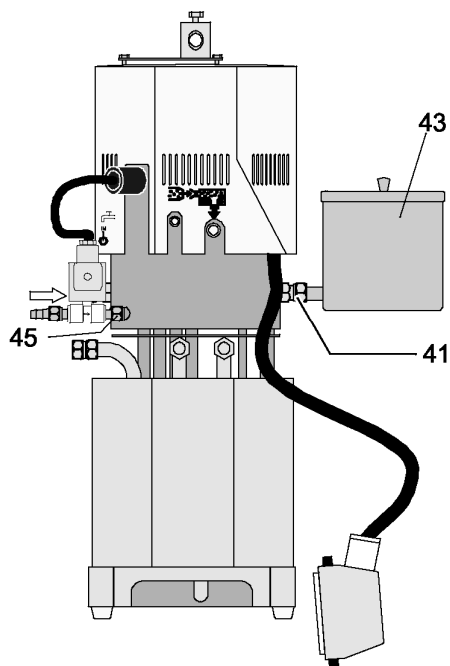

Installation of the magnetic valve

JULABO Order-No. 8 980 704 3 Magnetic valve

- Fix the expansion tank (43) to the connection (41) (open end wrench SW19)
- Screw the magnetic valve to the entry for cooling water (45). Respect the flow direction (arrow) Connect the cooling water to the magnetic valve and to the outflow of cooling water (44) by means of tubes 8 mm ID.
- Fix the control cable (56) at the control exit (56a) and screw tightly.

Adapter to reduce the pump pressure

JULABO Order-No. 8 970 802

With this adapter the pump pressure at the pump connection (51) can be reduced from 1,2 bar to 0,8 bar^{-0,1}.

Assembly

- Fix the adapter to reduce the pump pressure to the pump connections (50, 51) (open end wrench SW19).

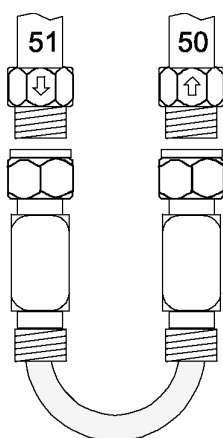

Notice:

When using pressure sensitive glass vessels, it is absolutely necessary to work with an adapter to reduce the pump pressure.

5.3. Bath liquids



CAUTION:

Carefully read the safety data sheet of the bath fluid used, particularly with regard to the fire point!

If a bath fluid with a fire point of $\leq 65\text{ °C}$ is used, only supervised operation is possible.



Important notice

Tempering liquid

The circulator can only be operated in closed tempering circuits. The contact of the tempering liquid with atmospheric oxygen only takes place in the not-flowed cooling zone. A safety equipment with definitely adjusted temperature value ($170\text{ °C} \pm 5\text{ °C}$) works independently from the control circle and supervises the temperature in the cooling zone. From 160 °C on the warning >hot cooling zone< is shown in line 4 of the DIALOG-DISPLAY (LCD). When the safety equipment reacts, the circulator is switched off all-pole and permanently. So it becomes possible to use tempering liquids with a flashpoint from 190 °C on.

From a working temperature of 200 °C on always work with counter-cooling.

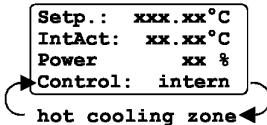

- Recommended bath liquids:

Bath liquids	Temperature range	Flash point	fire point
Thermal H20S	+20 °C ... 250 °C	>230 °C	>270 °C
Thermal H250*	+80 °C ... 250 °C	>225 °C	>250 °C
Thermal H350*	+50 °C ... 350 °C	>200 °C	>230 °C

* Thermal H250 and H350 can **only** be used in closed tempering circuits up to 250 °C or 350 °C

ATTENTION: The maximum permissible viscosity is $30\text{ mm}^2 \times \text{s}^{-1}$.

Order No.	Bath liquid	liters container
8 940 108	Thermal H20S	10
8 940 109		5
8 940 116	Thermal H250	10
8 940 117		5
8 940 111	Thermal H350	5



CAUTION:

Please contact JULABO before using other than recommended bath liquids. JULABO takes no responsibility for damages caused by the selection of an unsuitable bath liquid.

Unsuitable bath liquids are liquids which e.g.

- are very highly viscous
(much higher than $30 \text{ mm}^2 \times \text{s}^{-1}$ at the respective working temperature)
- have corrosive characteristics or
- tend to cracking.

5.4. Tubing

Metal tubing, triple insulated, M16x1, Temperature range -100 °C ... +350 °C

Order No.	Length
8 930 209	0.5 m
8 930 210	1.0 m
8 930 211	1.5 m
8 930 214	3.0 m

Metal tubing, insulated, M16x1, Temperature range -50 °C ... +200 °C

Order No.	Length
8 930 220	0.5 m
8 930 221	1.0 m
8 930 222	1.5 m
8 930 223	3.0 m

Pressure max. 6.0 bar at +20 °C
 4.6 bar at +200 °C
 3.8 bar at +350 °C



Important notice

Tubes:

In case of high working temperatures the tempering- and coolwater tubes are a danger source.

A failure of the counter-cooling, e.g. through broken tubes can cause higher temperatures in the cooling zone. Due to a damaged tempering tube hot tempering liquid can be pumped out within a short time.

These are possible results:

- Danger of fire
- Danger of explosion
- Burning of people's skin
- Difficulties in breathing due to hot atmosphere

JULABO Labortechnik supplies the metal tubes with assembly instructions (No. 1.950.0013). There all the instruction for assembly are indicated. They absolutely have to be respected.

Safety recommendations

- Employ suitable connecting tubing.
- Make sure that the tubes are securely attached.
- Avoid sharp bends in the tubing, and maintain a sufficient distance from surrounding walls.
- Regularly check the tubing for material defects (e.g. for cracks)..

5.5. Power connection



Warning:

- Connect control cable (55) with control exit (35) of the control electronics M1 and latch the safety loop.
Lengthening piece for control cable, 5 m - JULABO Order-No. 8 980 125
- If available screw the C.U.-cooling unit tightly to the control exit (56a) of the HT30 by means of the control cable (56).
- Connect the mains plug (37) of the control electronics to the earthed mains socket !

The available supply voltage and the power frequency have to be compared with the specifications on the type plate.

Voltage differences of $\pm 10\%$ are allowed.

No responsibility in case of wrong mains supply !

5.6. Filling / draining



Caution:

- The lines of the external system should be well cleaned in order to avoid soil particles (sand, metal chips) from being rinsed into the circulator. Danger for magnetic valves and the pump.
- The tempering liquid must not contain water!
Preparing the tempering liquid:
When heating up the oil to 110°C in an open bath, eventually existing water parts. Tempering time approximately 1 hour.



In case of high temperatures water parts in the tempering liquid can cause damages in the HT circulator!

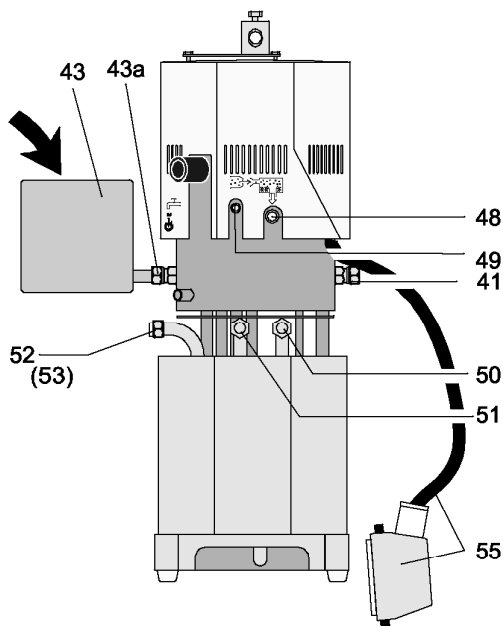

Filling

1. Attach a tube at the overflow nozzle (48) and lead it into a suitable vessel.
2. Remove the screw plugs from the pump connection (50, 51) and connect it to the external system by means of metal tubes (open end wrench SW19)
3. Remove the screw plug from the connection (43a) and screw down the expansion tank (43)
4. Always close tightly the connections which have not been used (e.g. 41 or 52, 53) with screw plugs, the drain plug (42) is also important.
5. Execute the mains supply (see above) and switch on the mains switch (1).
6. Fill the expansion tank and therefore at the same time the cooling zone with tempering liquid..
7. Operate key 
Internally a valve opens the passage to the heating zone. With a reduced no. of rotations the pump motor pumps the tempering liquid into the externally connected consumer.

8. Slowly refill tempering liquid until two or three segments of the level indication lighten. The necessary quantity of liquid then is in the tempering system.
9. If the minimum level liquid remains under, a low level alarm E01 can be caused. By a short switching-off and switching-on again at the mains switch (1) the alarm status is cancelled.

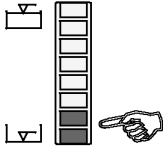

Afterwards again refill the tempering liquid and operate the key  until two or three segments of the level indication lighten.

10. Operate key  in order to finish the filling process.



Recommendation :

After each refilling a degasifying of the tempering liquid should be made.

Draining

1. Have cooled down the tempering liquid to a temperature below 40°C and only then switch off the circulator with the mains switch.
2. Place the circulator to the table edge and put under a suitable vessel to uptake the used tempering liquid.
3. For emptying unscrew the drain nut (42) on the front of the HT60 and have the tempering liquid run into a suitable vessel.



Caution:

Fasten tubing to prevent slipping.

Pay attention to the thermal expansion of bath oil during heating to avoid overflowing of the liquid.

Exercise caution when emptying hot bath liquids!



Notice:

Store and dispose the used bath liquid according to the laws for environmental protection.

5.7. Degasifying

During the filling process the pump fluidizes air bubbles into the tempering liquid. In the automatic degasifying mode those and other light solvent substances are slowly drained from the oil via the breather tube.





Notice:

In the automatic degasifying mode the breather tube between heating and cooling zone is opened again and again. Hot gases and self-extending tempering liquid therefore get into the cooling zone. Therefore in case of a target temperature which is higher than 150°C a counter-cooling in the cooling zone should be possible.

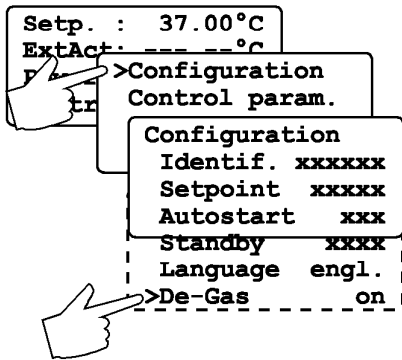
(See 5.8. Countercooling)

- Switch on the control electronics by the mains switch (1)
- With key  switch to „internal control“.
- Operate the following keys one after the other as described in order to get into the degasifying mode or to leave it. On the DIALOG-DISPLAY (LCD) the different actions can be followed-up.



1. MENU-key  1x
2. Enter-key  1x
3. Cursor-key  5x
4. P-key  1x
5. Enter-key  1x

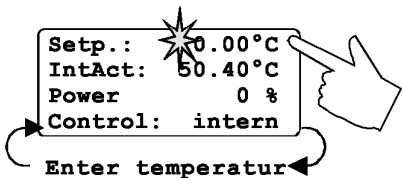

6. Now in line 4 of the DIALOG-DISPLAY there is the demand to set a temperature value („Enter temperature“) Example: 250°C

For this operate the following keys



With the Enter-key  the value is stored and

at the same time the degasifying mode is started. (Also see „Temperature setting“ page 22)

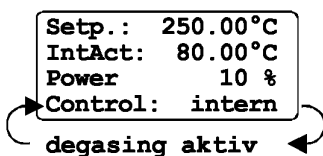

7. The temperature is automatically increased step by step by 2°C. Each time there is a standstill of approximately one minute. In line 4 of the DIALOG-DISPLAY (LCD) the degasifying mode is indicated by blinking.

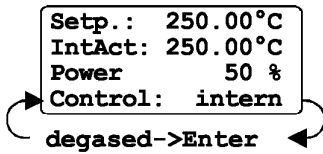

8. When the target temperature is reached, the degasifying mode is finished.

A signal tone sounds in intervals and in line 4 of the DIALOG-DISPLAY there is the demand to operate the

Enter-key .

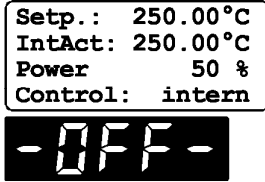



9. The DIALOG-DISPLAY (LCD) shows the standard indication, the circulator regulates to the last adjusted setpoint (in the example 250 °C) with the last adjusted control parameters.

The circulator is ready for use!





Stopping the degasifying:

- By operating the Start/Stop-key  the degasifying mode can be stopped at any time.
- The degasifying mode can also be left via the menu level . Proceeding as point 1 – 5.

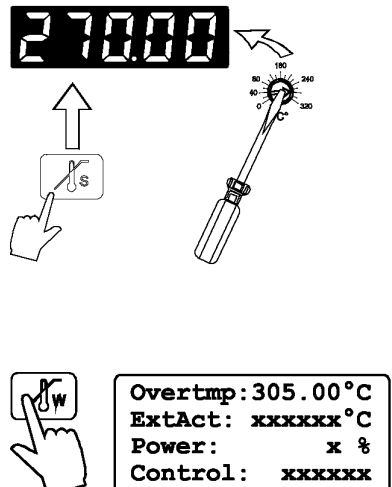
Important !
To avoid switching-off due to the excess temperature protection or –warning both settings should be checked and, if necessary, adjusted.



- Operate the setpoint-key  .
The MULTI-DISPLAY (LED) shows the present setpoint temperature (Example: 270.00°C). („Safety temperature“ see page 24)
- Operate the setpoint key  .
The DIALOG-DISPLAY (LCD) shows the present setpoint temperature (Examples: 305.00°C) („Warning functions“ see page 23)

5.8. Countercooling

On the HT60-circulator we distinguish two different cooling devices:
(Cooling water see page 60)

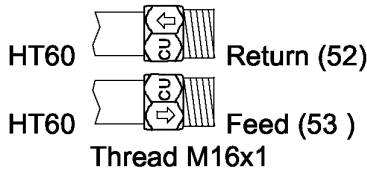
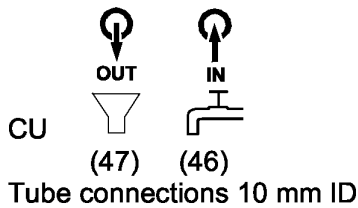
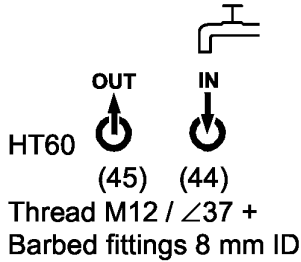

A cooling coil in the cooling zone for cooling water.

Without C.U.-cooling unit

The cooling water is directly connected to the connections (44, 45).

Flow of cooling water: app. 2 l/min at $T > 150\text{ }^{\circ}\text{C}$.
or

A magnetic valve for clocked cooling water is connected to the connection (44)

When required the control exit opens and closes the magnetic valve.

JULABO Order no.. 8 980 704 Magnetic valve

With assembled C.U.-cooling unit

the cooling water is connected to the connections (47, 46)
The flow of cooling water is controlled automatically.

1. A cooling coil in the C.U.-cooling unit for rapid cool-down of the tempering liquid

Via the pump connections (52, 53) the tempering liquid is led through the C.U.-cooling unit.

The heat is drained via the cooling water (47).

Comments:

- With an assembled C.U.-cooling unit the menu-point CoolingMax has to be set to a value of >0. So, the automatic control of the cooling can become active.
- In the C.U.-cooling unit water and oil temperature are supervised at each outflow.
The oil flow-through is interrupted when the oil temperature is app. 150 °C and the water temperature is app. 80 °C.

C.U.-cooling unit:

Cooling capacity at 2 l/min flow of cooling water.

Temperature <IntAct>	[°C]	350	250	150	75
Cooling capacity	[kW]	12	8	4	1



Caution:

Fasten tubing to prevent slipping.

From a working temperature of 200°C on always work with counter-cooling.

6. Operating procedures

6.1. Switching on / Selecting the language

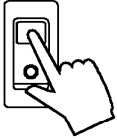

```
JULABO
HT-30/60
Controller
V 4.01-J
```

```
-OFF-
```

Switching on:

Turn on the mains power switch.

The unit performs a self-test.

All segments of the 5-digit MULTI-DISPLAY (LED), all indicator lights and the DIALOG-DISPLAY (LCD) will illuminate.

Then the software version (example: V 4.01-J) appears. The display "OFF" indicates the unit is ready to operate (standby mode).





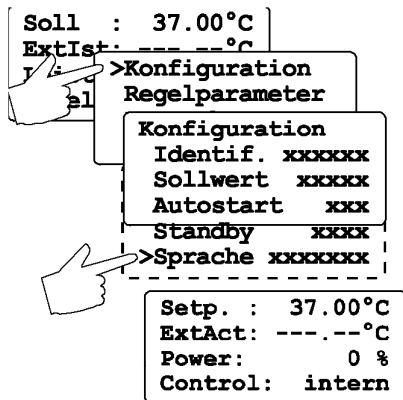

The high temperature circulator enters the operating mode activated before switching the programmable controller off: **keypad control mode** (manual operation) or **remote control mode** (operation via personal computer).

Selecting the language:

There are two options for the language of the DIALOG-DISPLAY (LCD): German or English. Select the desired language in the MENUE level under the configuration submenu.



Press the respective keys in the following order:

1. MENUE key  1 x
2. Enter key  1 x
3. Cursor key  4 x
4. P key  1 x
5. Enter key  1 x
6. Escape key  2 x

The DIALOG-DISPLAY (LCD) helps to follow up the individual settings. (example: swap the language from German to English.)

7. Manual operation

7.1. Start - Stop



21.03

Start:

- Press the start/stop key .
The MULTI-DISPLAY (LED) indicates the actual bath temperature. (example: 21.03 °C)

-OFF-

Stop:

- Press the start/stop key .
The MULTI-DISPLAY (LED) indicates the message "OFF".



The unit also enters the safe operating state "OFF" or "r OFF" after a mains power interruption. The temperature values entered via the keypad remain in memory. With the programmable controller in keypad control mode, press the start/stop key to restart operation. With the programmable controller in remote control mode, the personal computer must first resend the parameters set via the interface before the circulator may be restarted.



7.2. Setting the temperatures

This setting may be carried out with the high temperature circulator being in operating state Start or Stop!



Setp.: 50.00 °C
ExtAct: xxxxxx °C
Power xx %
Control: xxxxxx

Setting the working temperature "T":

- ① Press the setpoint key .
The value previously set appears on the DIALOG-DISPLAY (LCD) (example: 50.00°C).
A flashing segment indicates that a value needs to be entered.
- ② Use the keypad to enter the new value (example: 230.00 °C).
- ③ Press enter  to store the selected value.

2 3 0 

Setp.: 230.00 °C
ExtAct: xxxxxx °C
Power xx %
Control: xxxxxx

2 5 - 5 

(example 2: 25.50 °C).



Warning:

In case of high temperatures some parts of the High Temperature Circulators can get high surface temperatures when working continuously. Attention when touching !
During operation do not touch the heating and the cooling zone.

7.3. Warning functions

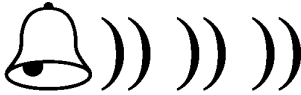

More protection for your samples in the bath!
An audible signal sounds in intervals when the actual temperature value exceeds one of the set limits (patented).



Setting the high temperature limit:



- ① Press the key .
The value previously set appears on the DIALOG-DISPLAY (LCD) (example: 305.00°C). A flashing segment indicates that a value needs to be entered.
- ② Use the keypad to enter the new value (example: 240.00 °C).
- ③ Press enter to store the value.

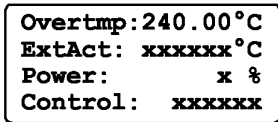

Setting the low temperature limit:



- ① Press the key .
- ② Follow the instructions
- ③ for (example: 220.00 °C).

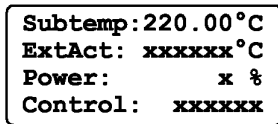

Note:
The warning functions will only be triggered when the actual bath temperature, after start from the „OFF“ or „rOFF“ mode, lies within the set limits for 3 seconds.

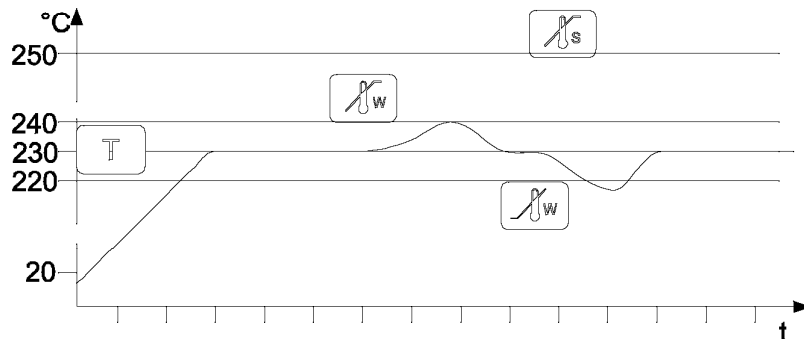

7.4. Setting the safety temperature (with shutdown function)

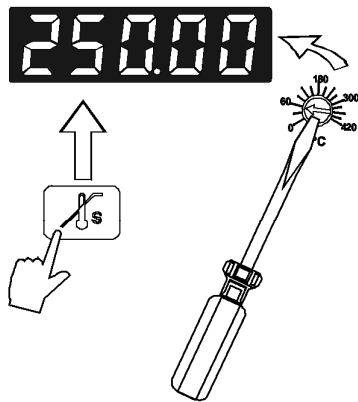

(excess temperature protection)

- Press the key to indicate the safety temperature value on the MULTI-DISPLAY and using a screwdriver simultaneously turn the setting screw to the desired value (example: 250 °C).

Setting range: 0 °C to 420 °C
in 2 °C steps

Safety device in the heating zone:

The safety device works independently from the control circle and supervises the temperature in the heating zone. If the temperature of the bath liquid reaches the safety temperature, a complete shutdown of the controlled heating device is effected.

The alarm is indicated by optical and audible signals (continuous tone).

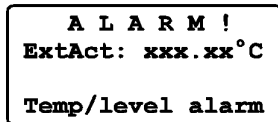
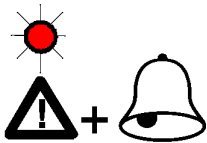

On the MULTI-DISPLAY (LED) and DIALOG-DISPLAY (LCD) appears the error message "E 14".

Cancel the alarm state (see page 46)

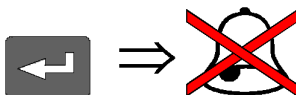

Recommendation:

- Set the safety temperature at 20 °C above the working temperature setpoint.
- From time to time the safety device has to be checked. With a screw driver turn back the adjustable overtemperature protection until the shut-down point (actual temperature).

Safety device in the cooling zone:

See „Important notice“ page 13

7.5. Internal / external control

The High Temperature Circulator offers the possibility of internal temperature control in a primary bath vessel or external control directly in an external system.

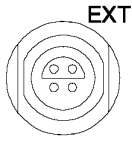

Setup for external control:

Connect a Pt100 sensor to the socket „EXT“ of the programmable controller, if necessary perform a calibration using the „ATC Ext:“ function (see 8.8. Sensors) and then securely fix the sensor in the external system.

Switching from internal to external control:

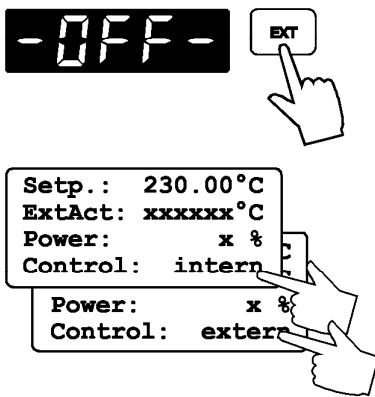



- Press the key  in operating state "OFF" to select the control type.
- The DIALOG-DISPLAY (LCD) indicates the effective control type.

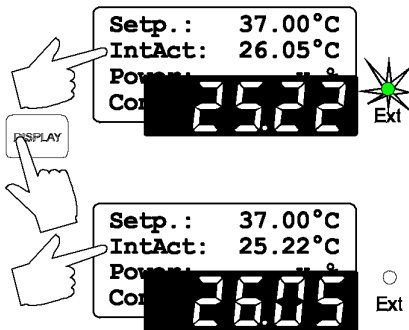

- Press the start/stop key .

Temperature indication:







- Both actual temperatures are indicated at the same time:
 - 1) on the MULTI-DISPLAY (LED)
 - 2) on the DIALOG-DISPLAY (LCD).
- Press the key  to swap the values on the displays. The indicator light „Ext“ refers to the indication on the MULTI-DISPLAY (LED).



Caution:

Place the external sensor into the bath medium and securely fix the sensor.

8. Menu functions

- Press the MENU key  to enter the menu level.
- Use the up/down cursor keys   to select the desired submenu and press enter .
- Press escape  to return to the previous menu level.

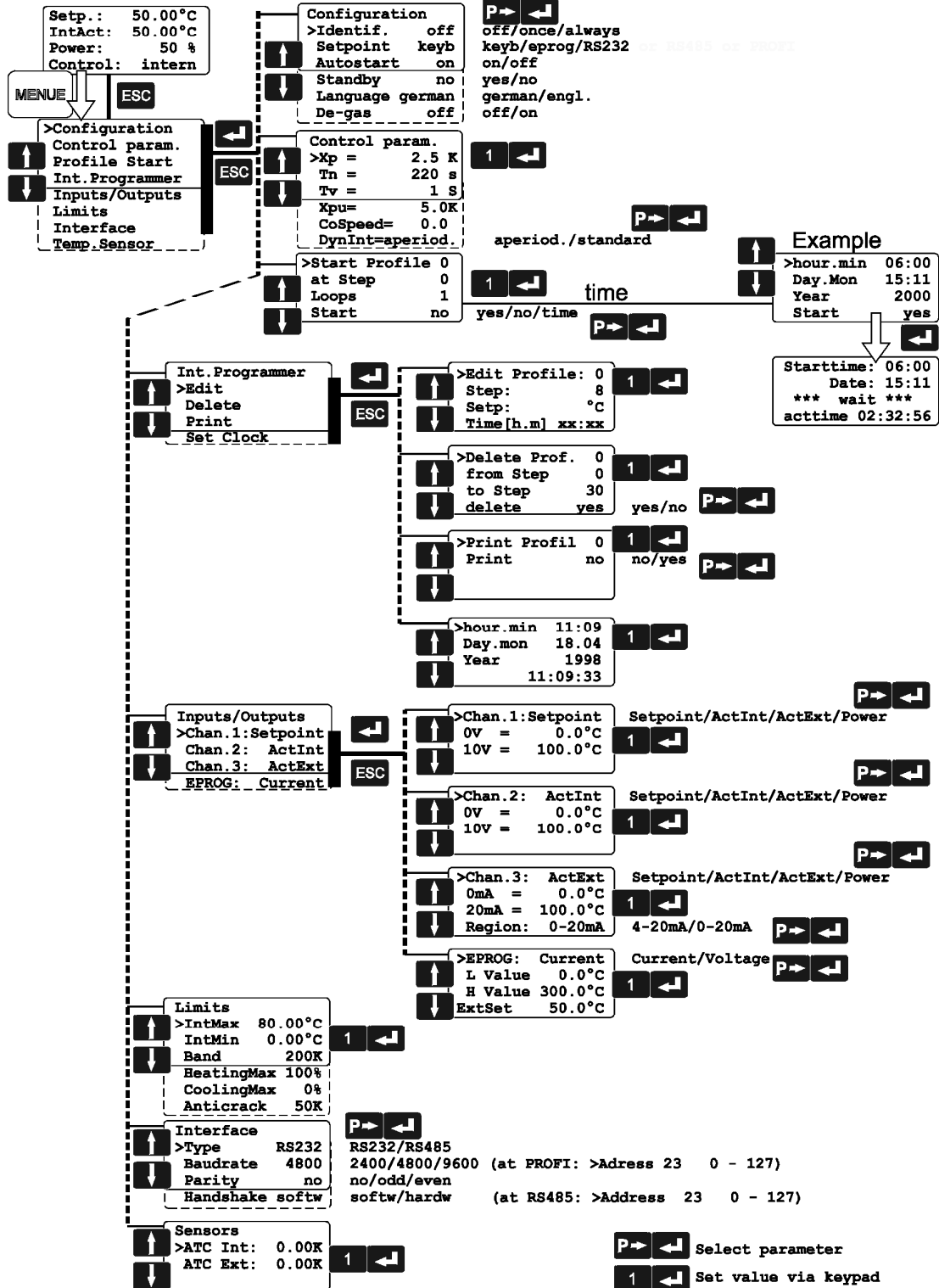

8.1. Configuration

By means of the configuration functions, operation of the High Temperature Circulator can be optimized for the current application.

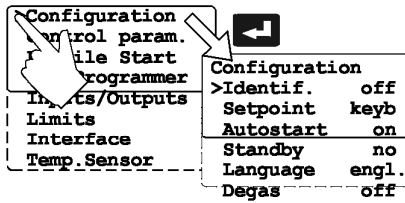

- Press enter to select the configuration submenu.
- Use the up/down cursor keys to select the desired option. A flashing line indicates that a value needs to be entered.
- Press the P-key to select the parameter and press enter .
- Press escape to return the previous menu level.

Identification

When performing an identification for the controlled system (temperature application system), the control parameters Xp, Tn and Tv will be automatically determined and stored.

Possible parameters:

off - no identification.

The control parameters ascertained during the last identification are used for control purposes.

once - single identification

The High Temperature Circulator performs a single identification of the controlled system after start. After the identification process the parameter is automatically set to "off".

always - continual identification

The High Temperature Circulator performs an identification of the controlled system whenever a new setpoint is to be reached.

NOTE: Use this setting only when the temperature application system changes permanently.

Note:

Requirement for an identification of the controlled system:

- The High Temperature Circulator must heat to a setpoint temperature at least 10 °C above the previous setpoint using the adjusted heating power.

- When the adjusted control parameters X_p , T_n and T_v are too high, this requirement may not be given with respect to on how much the setpoint temperature has to change. In this case, prior to carrying out an identification in the „OFF“ state, set the control parameters to lower values.

Recommended setting for internal control:

$X_p = 1.0 \text{ }^\circ\text{C}$

$T_n = 80 \text{ s}$

$T_v = 8 \text{ s}$

Setpoint

The programmable controller provides three possibilities for the setpoint selection. The selected mode is indicated on the DIALOG-DISPLAY (LCD).

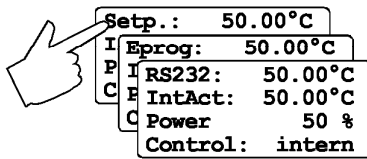

Possible parameters:

keyb- via keypad (working temperature T) or via the integrated programmer.

eprog - via the analog interface REG+E-PROG (31) through an external programmer.

RS232 - via the serial RS232/RS485 interface (30) through a PC or superordinated data system.



Autostart

Note:

The M2 / M3control electronic has been configured and supplied by JULABO according to N.A.M.U.R. recommendations. This means for the start mode, that the unit must enter a safe operating state after a power failure (non-automatic start mode). This safe operating state is indicated by „OFF“ or „rOFF“, resp. on the MULTI-DISPLAY (LED). A complete shutdown of the main functional elements such as heater and circulation pump is effected simultaneously.

Should such a safety standard not be required, the AUTOSTART function (automatic start mode) may be activated, thus allowing the start of the programmable controller directly by pressing the mains power switch or using a timer.

Possible parameters:**on** - AUTOSTART on**off** - AUTOSTART off**Warning:**

For supervised or unsupervised operation with the AUTOSTART function, avoid any hazardous situation to persons or property.

The High Temperature Circulator does no longer conform to N.A.M.U.R. recommendations.

Take care you fully observe the safety and warning functions of the programmable controller.



STAND-BY

Stand-by input

External stand-by for emergency switch-off
(connector - see page 49)

Possible parameters:**no** - stand-by input is ignored**yes** - stand-by input is active**Language**

There are two options for the language of the DIALOG-DISPLAY (LCD): German or English.

Possible parameters:**German (deutsch)****English (engl.)****Degasifying**

During the filling process the pump fluidizes air bubbles into the tempering liquid. In an automatic degasifying mode those and other light solvent substances are let out via a breather tube.

Adjustable parameters:**off** – Degasifying mode switched off**on** – Degasifying mode switched on

(Also see page 18)

8.2. Control parameters

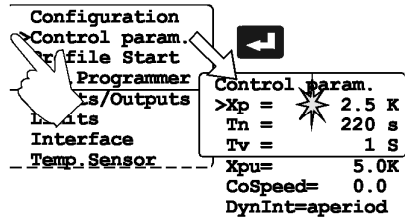

Xp = **2** **-** **5** **↵**

When performing an identification for the controlled system (temperature applications system) (see page 27), the control parameters Xp, Tn, and Tv will be automatically determined and stored.

Each parameter may be manually set via the keypad if necessary, to allow optimum control performance.

- Press enter **↵** to select the submenu „control parameters“.
- Use the up/down cursor keys **↑** **↓** to select the desired option. A flashing segment indicates that a new value needs to be entered.
- Use the numeral keypad to set the value and then set with enter **↵** (example: Xp = 2.5 °C).

- or at >DynInt<
Press the P-key **P→** to select the parameter and press enter **↵**.

- Press escape **ESC** to return to the previous menu level.

Proportional range >Xp<

The proportional range is the range below the selected temperature value in which the the control circuit reduces the heating power from 100 % to 0 %.

Resetting time >Tn< (Integral component)

Compensation of the remaining control deviation due to proportional regulation. An insufficient resetting time may cause instabilities to occur. Excessive resetting time will unnecessarily prolong compensation of the control difference.

Lead time >Tv< (Differential component)

The differential component reduces the control settling time. An insufficient lead time will prolong the time required to compensate for disturbance effects and cause high overshooting during run-up. An excessive lead time could cause instabilities (oscillations) to occur.



JULABO
HT-30/60
Controller
V 4.01-J

Note:

The parameters >Xpu<, >CoSpeed< and >Dynamik< are only supported from the programme version V4 xx. If the control electronics (V 4.xx) M2 respectively M3 is combined with an older version of the HT60 circulators, these parameters are not available. They are not indicated in the menu.

Proportional range >Xpu<

The proportional range Xpu of the cascaded controller is only needed for external control..

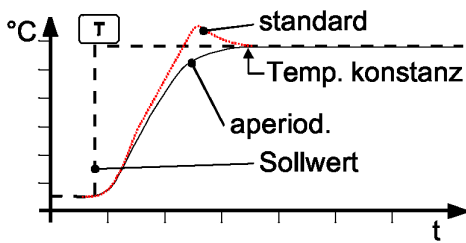

>DynInt< - Dynamics

This parameter affects the march of temperature only in case of internal control (see page 25)

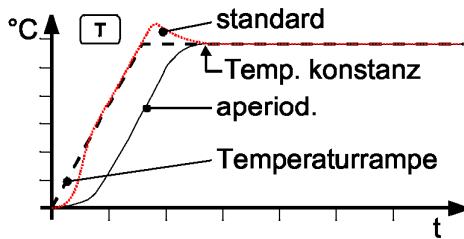

Adjustable parameter:

standard The temperature rises quicker, however can overshoot up to 5 %. If a ramp is defined, the march of temperature often follows this ramp.

aperiod. The temperature rises chronologically without overshoot.

With both adjustments a sufficient temperature stability is reached after approximately the same time.

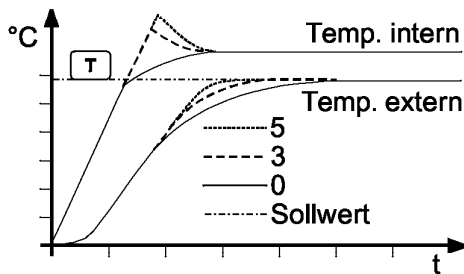

>CoSpeed< 0 up to 5

This parameter affects the march temperature only in case of external control (see page 25).

The adjustment affects the calculation of the control parameter when identifying and so the control course.

Optimization instructions for the PID control parameters:

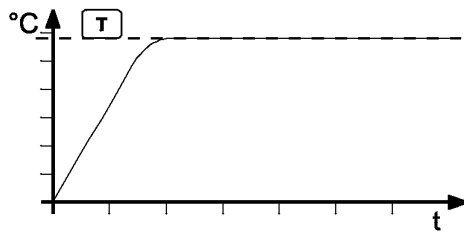

The heat-up curve reveals inappropriate control settings.
(example: working temperature T)

optimum setting

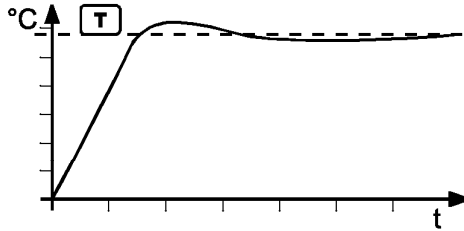

Inappropriate settings may produce the following heat-up curves:

X_p too low

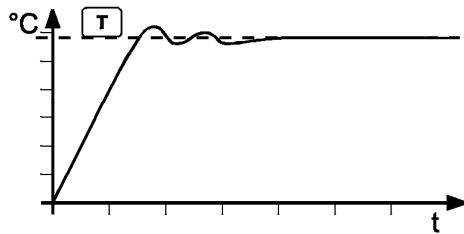

T_v/T_n too low

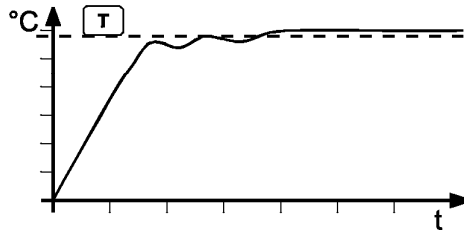

X_p too high
or
 T_v too high

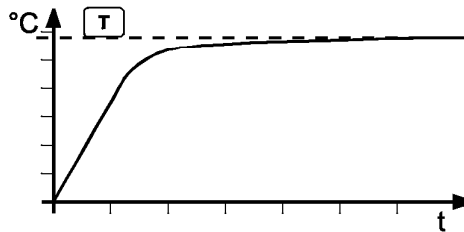

T_v/T_n too high
or
 X_p too high

8.3. Start of a profile

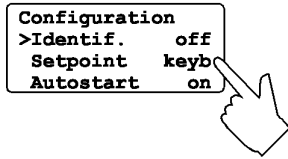

The start menu of the High Temperature Circulator allows calling up and defined starting of one of six previously stored temperature profiles. This start can be effected manually or be released by an integrated timer.

Important:

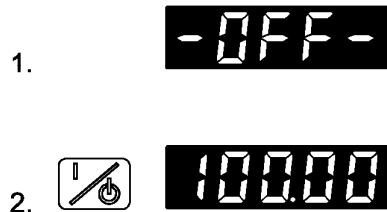

In the menu configuration under menu point „setpoint“ operation has to be set via „key“.

There are two possibilities for manually starting a program:



1. Starting a program from the OFF status:
The programmer switches back to the OFF status at the end of the program.
2. Starting a program from the operating status.

The programmer is started with the Start key , and the bath is heated to the desired temperature, for example 100 °C. At the end of the program, the programmer switches to the operating status and holds the bath temperature stable at 100.00 °C.

- Press enter  to select the submenu „Profile Start“.
- Use the up/down cursor keys   to select the desired option.

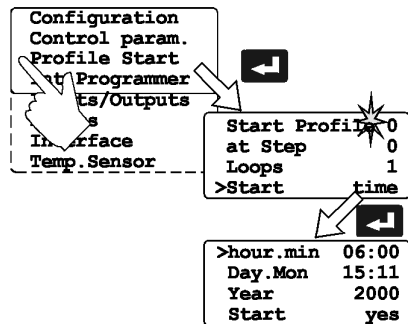



A flashing segment indicates that a number needs to be entered.

Start Profile 0 to 5
at Step 0 to 60
Loops 1 to 99

Enter the desired number and set each entry with enter .

Start no / yes ⇔ (manual start)
 or
time ⇔ (via integrated timer)

A flashing line indicates that a parameter needs to be entered.

Press the P-key  to select the respective parameter and press enter .

Example: hour.min 6:00 h



```
>hour.min 06:00
Day.Mon 15:11
Year 2000
Start yes
```

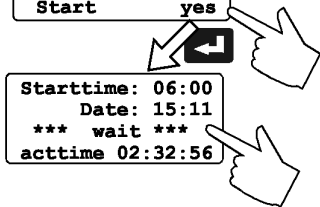

```
Starttime: 06:00
Date: 15:11
*** wait ***
acttime 02:32:56
```

- When selecting the parameter **time**, a new menu level is called up for entry of the start time. A flashing segment indicates that a start time needs to be entered.

hour.min Start time
Day.Mon day and month
Year year

Set each entry with enter

Start no / yes

A flashing line indicates that the parameter „yes“ needs to be entered.

Press the P-key to select the parameter and press enter .

- The High Temperature Circulator switches to waiting mode and a flashing line „wait“ appears on the DIALOG-DISPLAY (LCD). The start time and actual time are permanently indicated on the display.

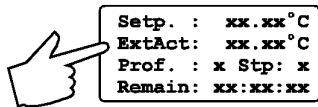
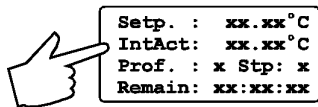

Indication after starting the profile:

DIALOG-DISPLAY (LCD)

- 1st line: Setpoint of the programmer
- 2nd line: Actual temperature value
 at **internal control** = IntAct: xxx.xx
 at **external control** = ExtAct: xxx.xx
- 3rd line: Selected profile and the actual section
- 4th line: Remaining time of the actual section

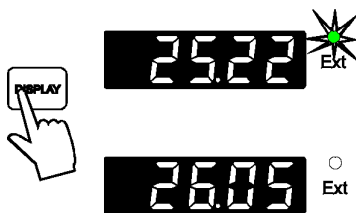

MULTI-DISPLAY (LED)

If the circulator is operated through the **integrated programmer** the MULTI-DISPLAY (LED) swaps between the two actual values (internal and external)

8.3.1. Interrupting a profile

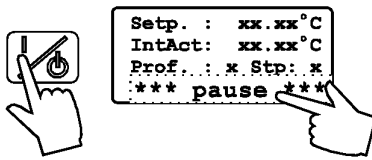

Interrupting a profile:

Press the start/stop key  to interrupt or restart a profile. The setpoint and time period set for the corresponding section are thus stopped at the values presently achieved. The programmable controller is put on hold and the message „pause“ flashes on the DIALOG DISPLAY (LCD).

- A profile can be interrupted or restarted by an external emergency shut-off.(see page 49).



CAUTION:

This is not an actual emergency shut-off!

- The setpoint control and the timer are interrupted by breaking the contact “AK”. The programmer switches to the waiting position, while displaying this condition with a blinking LCD display.

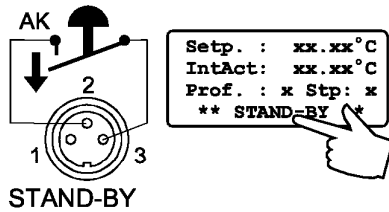

Important:

To achieve this, the Stand-by condition must first be activated and the Autostart function turned on. (see page 29).







Warning:

Following a power interruption, it would be possible in this condition for the programmer to restart automatically. The safety and warning functions of the programmer should always be used to their fullest capacity.

See warning page 29

Termination of a profile:

A profile can be terminated by pressing the escape key . The programmer switches back to the Start menu.

- Press escape  again to leave the menu or use the cursor keys   to remain in the Start menu.

The execution of another temperature profile can now be prepared if necessary.

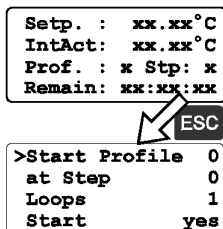

8.4. Integrated programmer

The integrated programmer allows any desired temperature program sequences to be realized. Such a temperature sequence is called profile. A profile consists of individual sections defined by duration (t:) and target temperature. Target temperature is the setpoint (T:), that is achieved at the end of a section. The programmer uses time and temperature difference values within a section to calculate a temperature ramp.

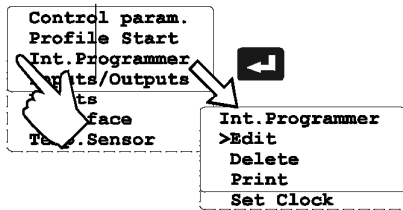

- Press enter to select the submenu „Int. Programmer“.
- Use the up/down cursor keys to select the desired option. Then press enter to open. A flashing segment indicates that a number or value needs to be entered.

- Edit** Compile profiles
 Display sections
- Delete** Delete sections
- Print** Print a programmed profile
- Set clock** Set the real time on the programmable controller

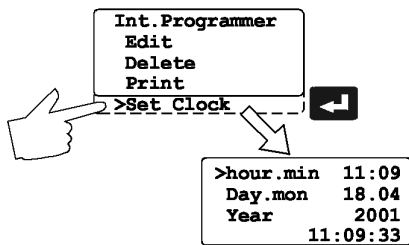

Setting the clock

The integrated clock provides the flexibility to start a profile at any date and time. The clock is preset at the JULABO factory.

- Lines 1 to 3:
Check for correctness of the preset date and time and correct if necessary.

The time is displayed permanently in line 4.

Examples:

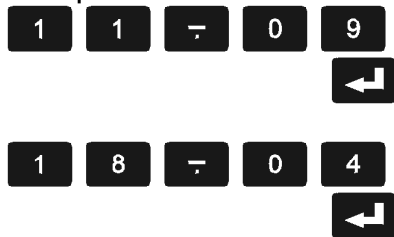

- Use the numerals to set time, date and year and set each entry with enter .
- Press escape to return to the previous menu level.

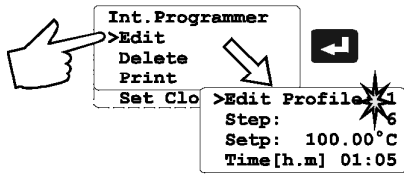

Edit

Compile profiles:

- A flashing segment indicates that a number needs to be entered. Under submenu „Edit Profile“ enter a profile number. Six profiles may be stored (nos. 0 to 5).
- Then programme the desired values for each section. Use the keypad to set section number, target temperature and time period. Set each entry with enter

Examples:

Profile No. 1

Step

Setpoint

Time

When the program is running, only sections having complete information for target temperature and time period are considered.

It makes sense, to leave out section numbers in the profile, in order to use them later for corrections in the profile.

Important:

If a time of 00:00 is set for a profile, the profile is continued with the next section only after the setpoint temperature (± 0.2 °C) is reached.

- Press escape to return to the previous menu level.

Example:

Step (No.)	1	3	5	6	9	11	14
Setpoint (°C)	50	50	100	100	80	80	20
Time (h:m)	00:08	00:02	00:10	01:05	00:10	00:05	00:30

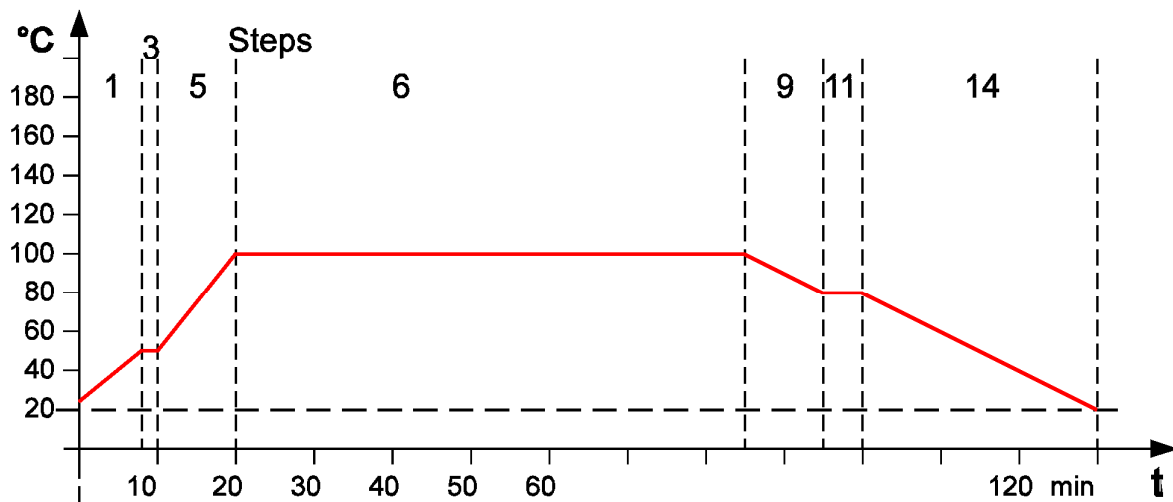

Step

```

Edit Profile: 1
>Step: 3
Setp: 50:00°C
Time[h.m] 00:02
    
```

Display sections:

- Use the cursor keys to select the submenu „Step“, enter the desired number and press enter .
- The values previously set are displayed.

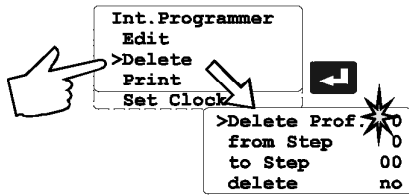

Delete

- A flashing segment indicates that the respective profile number needs to be entered in which one or more consecutive sections are to be deleted.
- In lines 2 and 3 of the DIALOG DISPLAY (LCD) enter the numbers of the sections to be deleted. Press enter

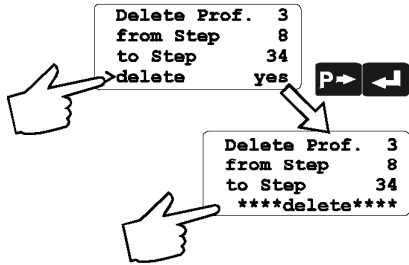

delete no / yes

Press the P-key to select the parameter „yes“ and press enter . Line 4 indicates the deletion.

Example:
Delete section 8 to section 34 in profile 3.

- Press escape to return to the previous menu level.

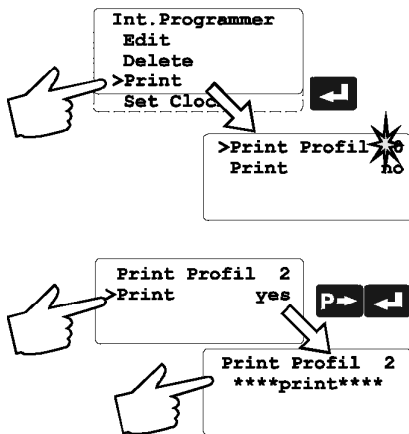

Print

Each profile may be printed via the serial interface for control or documentation.

- A flashing segment indicates that the number of the profile to be printed needs to be entered.

Print no / yes

Press the P-key to select the parameter „yes“ and press enter .

Printing is indicated in line 2.

Profile 1		
Step 0	not defined!	
Step 1	50	00:08
Step 2	not defined!	
Step 3	50	00:02
Step 4	not defined!	
Step 5	100	00:10
Step 6	100	01:05
Step 7	not defined!	
Step 8	not defined!	
Step 9	80	00:10
Step 10	not defined!	
Step 11	80	00:05
Step 12	not defined!	
Step 13	not defined!	
Step 14	20	00:30
Step 15	not defined!	
	etc.	

This printing example shows the profile given as example on page 37.

8.5. Analog inputs/outputs

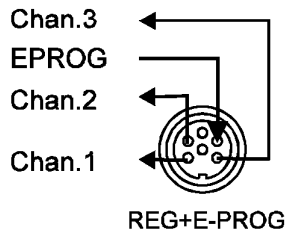

This submenu enables setting of the input and output values for the programmer input and the temperature recorder outputs of socket REG+E-PROG (31).

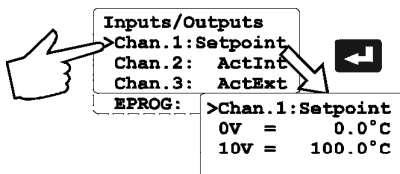
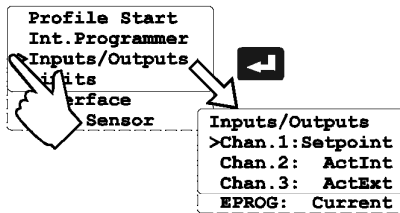

- Press enter to select the inputs/outputs submenu.
- Use the up/down cursor keys to select the desired option and press enter to open.
 - Chan.1** voltage output for recorder (V)
 - Chan.2** voltage output for recorder (V)
 - Chan.3** current output for recorder (mA)
 - EPROG** external programmer input

First define the desired output value for channels 1 to 3:

Press the P-key to select the desired output value and set with enter .

- Setpoint** active setpoint temperature (T, integr. programmer/ext. programmer)
- ActInt** internal actual temperature value (bath temperature)
- ActExt** external actual temperature value (external sensor)
- Power** periodic or intermittent heating or cooling

- Then select the display size for channels 1 to 3:

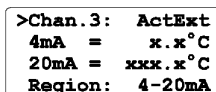
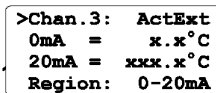
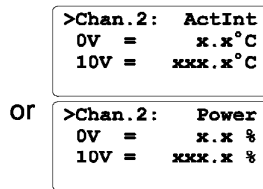

Channel 1 and 2 voltage outputs

Assign the voltage values of 0 V to the lowest and 10 V to the highest necessary temperature or power rating required as an output value (°C or %).

Current output channel 3

Assign the current values 0 mA or 4 mA to the lowest and 20 mA to the highest temperature or power rating required as an output value (°C or %).

The current output offers 2 ranges for selection: 0 to 20 mA and 4 to 20 mA.

Select the desired range by pressing the P-key

and set with enter . The LCD display changes automatically.

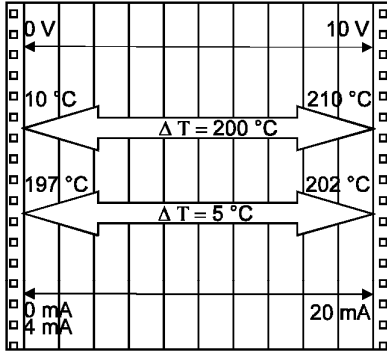

Examples:

lowest temperature value: 10 °C
 highest temperature value: 210 °C
 Fig. shows 200 °C scaled to paper width
 rise: 50 mV/°C

lowest temperature value: 197 °C
 highest temperature value: 202 °C
 Fig. shows 5 °C scaled to paper width
 rise: 2000 mV/°C

```
>EPROG: Current
L Value 0.0°C
H Value 300.0°C
ExtSet 50.0°C
```

EPROG - Input

This input is necessary when the nominal value is to be determined and set by an external programmer.

Connect the external programmer to socket (31) REG+E-PROG of the programmable controller.

- The programmer input of the programmable controller can be matched to the output signal of the external programmer.

Voltage voltage input
Current current input

Select the desired input value with the P-key **P** and set with enter **↵**.

- „L Value“ - **Setting the LOW value:**
 Adjust and set the lowest desired working temperature on the programmer (e.g. 0 °C).
 Enter this same temperature on the programmable controller by pressing the appropriate buttons on the keypad and press enter **↵** to set.
- „H Value“ - **Setting the HIGH value:**
 Adjust and set the highest desired working temperature on the programmer (e.g. 300 °C).
 Enter this same temperature on the programmable controller by pressing the appropriate buttons on the keypad and press enter **↵** to set.
- Return to the standard display by pressing escape **ESC**.

Example:

```
>EPROG: Current
L Value  0.0°C
H Value  300.0°C
ExtSet   50.0°C
```

ESC 3x

```
EPROG : 50.00°C
IntAct: 50.00°C
Power:  50 %
Control: intern
```

- Setting a temperature of 50 °C on the external programmer!

The value adjusted and set on the external programmer is displayed in line 4 of the DIALOG-DISPLAY (LCD) for control purposes (Example: ExtSet: 50.0 °C).

After returning the LCD display to standard display by

pressing escape **ESC** („Setpoint“ - see page 28) this value is displayed in line 1 (Example: EPROG 50.00 °C).

This EPROG input enables the use of different voltage and current values as program parameters.

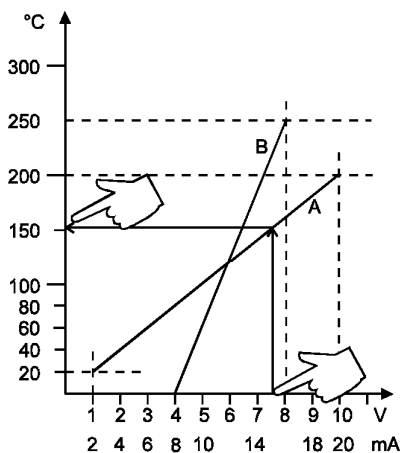

- „L Value“ - Setting the LOW value:

- 1) Adjust and set the lowest desired value on the voltage or current source resp. (Example A: 1 V).
- 2) Assign a lower temperature threshold value to this adjusted voltage/current value by pressing the appropriate buttons on the keypad of the programmable controller

(Example A: 20 °C) and set by pressing enter .

- „H Value“ - Setting the HIGH value:

- 1) Adjust and set the highest desired value on the voltage or current source resp. (Example A: 10 V).
- 2) Assign an upper temperature threshold value to this adjusted voltage/current value by pressing the appropriate buttons on the keypad of the programmable controller

(Example A: 200 °C) and set by pressing enter .

- Return to the standard display by pressing escape **ESC**.

Example B in the diagram serves to illustrate that the end point values are freely selectable.

Example out of diagram A:

- Adjusting the voltage source for an output of 7.6 V!

Line 4 of the DIALOG-DISPLAY (LCD) shows the externally set setpoint value. The programmable controller calculates this value from the rise angle of the two predecided end points (in example A: 7.6 V correspond to an external setpoint temperature of 152.0 °C).

After returning the LCD display to standard display by

pressing escape **ESC**, this value is displayed in line 1 (Example: EPROG 152.00 °C).

**Notice:**

If this adjustment is not correctly performed at two different points, the setpoint setting will be incorrect.

8.6. Limits

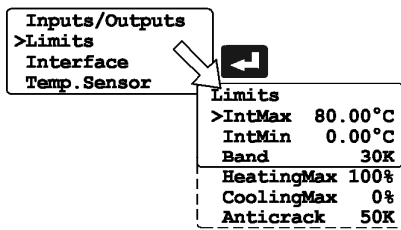

The limits IntMax and IntMin are only valid under external control (see 7.5. Internal / external control) They restrict the temperature of the internal bath to the desired maximum/minimum, also if the controller would require a higher/lower temperature for the external system. As a result the external setpoint may thus not be reached.

When operating the programmable controller under external control, band limiting is active. The preset value determines the maximum temperature difference between the internal bath and the external load. This adjustment possibility prevents sensitive equipment and temperature devices from damage.

The limitation „Crack protection“ shall avoid a partial overheating of the still thick-flowing temperature liquid after switching on the circulator.

Heating and cooling power of the programmable controller are adjustable.

100 % corresponds to the values in the technical specifications of the equipment.

- Select the submenu „Limits“ with enter
- Select the desired option with the up/down cursor keys .

A flashing digit indicates that a value needs to be entered.

IntMax	see working temperature range page 59
IntMin	see working temperature range
Band	0 to 200 °C
HeatingMax	0 to 100 % in steps of 1 %
CoolingMax	0 to 100 % in steps of 1 %
Anticrack	30 K to 100 K

Factory settings:	
Band	200 K
HeatingMax	100 %
CoolingMax	0
Anticrack	30 K

- To set the newly entered value press enter .
- To return to the previous menu level press escape .



Notice: - CoolingMax –

The assembled C.U.-cooling unit the menu point CoolingMax has to be set to a value >0 (Recommendation: 100%). So the automatic control of the cooling can become active.



Notice:

The parameters >IntMax< and >IntMin< are only supported from programme version V°4.xx on. If the control electronics (V 4.xx) M2 respectively M3 is combined with an older version of the HT60 circulator, these parameters are not available. They will not be indicated in the menu.

8.7. Interface

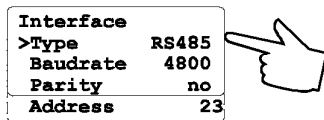
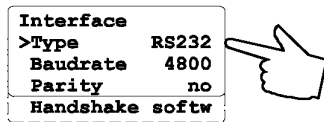
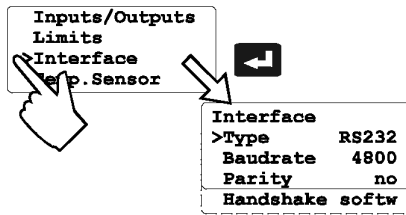

The interface parameters are set by selecting the submenu „Interface“ on the programmable controller. Normally, this is a one-time-only adjustment.

- Press enter to select the submenu „Interface“.
- Select the desired option with the up/down cursor keys . Enter the desired value for the flashing digit.

Type	RS232 / RS485
Baudrate	2400/4800/9600
Parity	none/even/odd
Handshake	software handshake/hardware handshake
Address	0 to 127
- Press the P-key to select the desired parameter and set with enter .
- Return to the previous menu level with escape .

Factory settings

see - 12.1.

Setup for remote control

8.8. Sensors

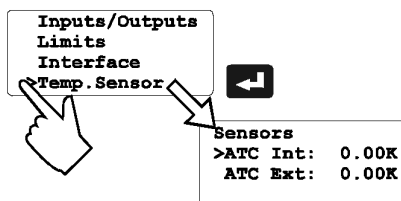

ATC - Absolute Temperature Calibration

- Select the submenu „Temp.Sensor“ with enter .
- Select the desired option with the up/down cursor keys . A flashing digit indicates that a value needs to be entered i.e. set.

ATC Int:	internal sensor
ATC Ext:	external sensor

Einstellbereich jeweils ± 9.99 K

- Enter the desired compensating value and set this value by pressing ENTER .

Circulator (T_T)

50.00

Measuring point (T_M)

49.20



Sensors
>ATC Int: -0.80K
ATC Ext: 0.00K

ATC Int:

ATC serves to compensate a temperature difference that might occur between circulator and a defined measuring point in the bath tank because of physical properties.

- The difference temperature ($\Delta T = T_M - T_T$) is determined and stored as compensating value (example $\Delta T = -0.8 \text{ }^\circ\text{C}$).
- Use the keypad to enter the desired compensating value (e.g. -0.80) and set with enter .

- The temperature on the measuring point rises to a temperature of 50.0 $^\circ\text{C}$ and is indicated on the MULTI-DISPLAY (LED).



Note:

The compensating factor always affects the actual working temperature, even when set via the interface connection.



ext. Pt100

Circulator (T_T)

50.00



Setp.: 50.00 $^\circ\text{C}$
ExtAct: 51.22 $^\circ\text{C}$
Power: 100 %
Control: intern

External sensor (T_{Pt100})

Sensors
>ATC Int: -0.80K
ATC Ext: 1.22K

ATC Ext:

serves calibration of an external Pt100 sensor.

- Immerse the Pt100 sensor in the circulator bath tank and allow the bath temperature to stabilize at 50 $^\circ\text{C}$, for example.
- Read the temperatures of the factory calibrated circulator (T_T) and the external Pt100 sensor (T_{Pt100}) in their respective displays.
- Calculate the temperature difference and enter and set this difference value as the ATC external compensating parameter. (Example: $\Delta T = T_{Pt100} - T_T = 1.22 \text{ }^\circ\text{C}$)
- Use the keypad to enter the desired compensating value (e.g. 1.22 $^\circ\text{C}$) and set with enter .



Notice:
The ATC function remains active until reset to 00.00 $^\circ\text{C}$.

9. Troubleshooting guide / Error messages

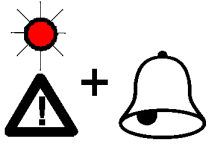

Whenever the microprocessor electronics registers a failure, a complete shutdown of the circulator is performed. The alarm light "▲" illuminates and a continuous signal tone sounds.

E 01

- The circulator is operated without bath liquid, or the liquid level is insufficient. Replenish the bath tank with the bath liquid.
- Tube breakage has occurred (insufficient filling level due to excessive bath liquid pumped out). Replace the tubing and replenish the bath tank with the bath liquid.
- The float is defect (e. g., because damaged in transit). Repair by authorized JULABO service personnel.

E 02

- Failure of one or both temperature sensors of the C.U.-cooling unit.
- The cooling water temperature value lies below 5 °C.

E 05

- Cable of the working temperature sensor interrupted or short-circuited.

E 06

- Defect of the working or safety temperature sensor. Working temperature and safety sensors report a temperature difference of more than 100 °C.

E 07

- Other errors (I²C-BUS errors)

E 12

- Error in A/D converter.

E 14

- Safety sensor defect.
- The safety temperature value lies below the working temperature setpoint. Set the safety temperature to a higher value.

E 15

- External control selected, but external Pt100 sensor not connected.

E 19

- Error in the measuring system of the external temperature sensor „EXT“.

E 31

- Error at the internal Interface

E 33

- Safety sensor 1:
Cable of the safety sensor 1 interrupted or short-circuited.

E 34

- Safety sensor 2:
Cable of the safety sensor 2 interrupted or short-circuited.



- Safety sensor 3:
Cable of the safety sensor 3 interrupted or short-circuited.



- Safety sensor in the cooling zone:
Cable of the safety sensor interrupted or short-circuited.



- Safety sensor in the cooling zone: The temperature in the cooling zone has exceeded 170 °C. See „Important notice“ Page 13.

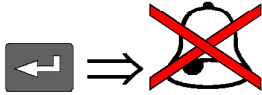

- Press enter  to quit the audible signal.

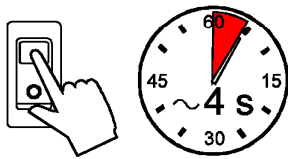

After eliminating the malfunction, press the mains power switch off and on again to cancel the alarm state.

- If the unit cannot be returned to operation, contact an authorized JULABO service station.



Mains Fuses: M2, M3

- The mains circuit breakers (resettable) for the circulator (16 A) and the CU-unit (4 A) on the rear of the housing are safety machines.

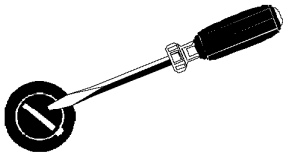

Mains Fuses: M2

The mains fuses (36) on the rear of the unit may easily be exchanged as shown on the left – T 16 A.



Warning:

Before exchanging the fuses, turn off the mains power switch and disconnect the power plug from the mains socket!
Only use fine fuses with a nominal value as specified.





Example:

Manufacturer	Supplier	Type	Order No.
Schurter	Schurter	G-fuse insert SPT T16A 5x20mm	No. 0001.2516

10. Safety recommendations

Follow the safety recommendations to prevent damage to persons or property. Further, the valid safety instructions for working places must be followed.

Also see chapter 14. Responsibility of the operator

	<ul style="list-style-type: none"> • Connect the unit only to a grounded mains power socket! • Place the circulator on an even surface on a pad made of non-inflammable material.. • Set the value for safety temperature. • Pay attention to the thermal expansion of bath oil during heating to avoid overflowing of the liquid. • Prevent water from penetrating into the hot bath oil. • Exercise caution when emptying hot bath liquids! • Employ suitable connecting tubing. • Make sure that the tubes are securely attached. • Avoid sharp bends in the tubing, and maintain a sufficient distance from surrounding walls. • Regularly check the tubing for material defects (e.g. for cracks).. • Before cleaning the unit, disconnect the power plug from the mains socket.
	<p>Warning: Hot surface Some parts of the HT circulator may become extremely warm during continuous operation. Therefore, exercise particular caution when touching these parts. During operation do not touch the heating and the cooling zone .</p>
	<p>Notice: Recommendation: When you have finished the application, it is recommended to keep on circulating the liquid in the bath or the external system for some time. Simultaneously set the working temperature to +20 °C to allow the temperature in the system to decrease slowly. Thus fractional over-heating of the bath liquid is prevented.</p>
	<p>Notice: Please check the safety device from time to time.</p> <ul style="list-style-type: none"> • Over temperature protection according to DIN 12876-1-2000 With a screw driver turn back the adjustable over temperature protection until the shut-down point (actual temperature). • Low level protection To check the function the float of this unit cannot be operated manually. The 8 tier level display should therefore be observed whenever refilling. If the temperature liquid thickens or it is cracked, the circulator should be cleaned and checked by a specialist.

11. Electrical connections

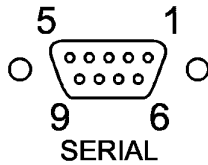

RS232/RS485 serial interface (30)

This port can be used to connect a computer with an RS232 or RS485 cable for remote control of the circulator.

Pin assignments: RS232

Pin 2	RxD	Receive Data
Pin 3	TxD	Transmit Data
Pin 5	0 VD	Signal GND
Pin 6	DTR	Data terminal ready
Pin 7	RTS	Request to send
Pin 8	CTS	Clear to send

Pin assignments: RS485

Pin 3	A	
Pin 5	0 VD	Signal GND
Pin 8	B	
Pins 1, 2, 4, 6, 7, 9		Reserved - do not use!

Interface correspondence:

Circulator	Computer	Circulator	Computer
9-pole	25-pole	9-pole	9-pole
Pin 2 RxD	⇔ Pin 2 TxD	Pin 2 RxD	⇔ Pin 3 TxD
Pin 3 TxD	⇔ Pin 3 RxD	Pin 3 TxD	⇔ Pin 2 RxD
Pin 5 GND	⇔ Pin 7 GND	Pin 5 GND	⇔ Pin 5 GND
Pin 6 DTR	⇔ Pin 6 DSR		
Pin 7 RTS	⇔ Pin 5 CTS	Pin 7 RTS	⇔ Pin 8 CTS
Pin 8 CTS	⇔ Pin 4 RTS	Pin 8 CTS	⇔ Pin 7 RTS



Use shielded cables only.

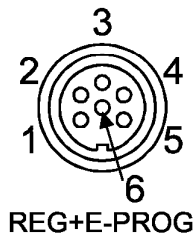

Programmer input / temperature recorder output (31)

Analog inputs / outputs see page 39

Pin	Signal
1 Voltage output	Channel 1 0 ... 10 V
2 Voltage output	Channel 2 0 ... 10 V
3 GND for outputs	0 V
4 Programmer input	EPROG 0 to 10 V / 0 to 20 mA
5 Current output	Channel 3 0 to 20 mA / 4 to 20 mA
6 GND for Programmer	0 V



Use shielded cables only..

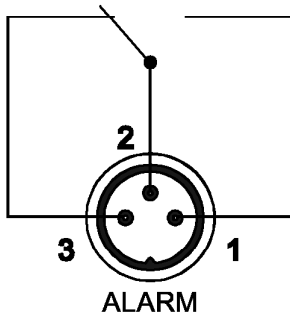

Alarm output (33)

(for external alarm signal)

This potential-free change-over contact is activated in case of an alarm when pins 2 and 3 are connected.

Switching capacity	max.	30 W / 40 VA
Switching voltage	max.	125 V~/–
Switching current	max.	1 A

Use shielded cables only.

STAND-BY input (32)

(for external emergency switch-off)

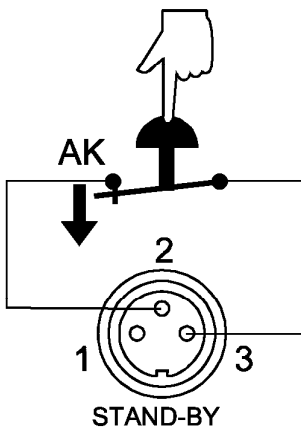

Pin assignment:	<u>Pin</u>	<u>Signal</u>
	1	not connected
	2	5 V / DC
	3	0 V

Use shielded cables only.

Activate the stand-by input:

- Under menu item Stand-by, set the parameter to „yes“ (see page 29).
- Connect an external contact 'AK' (e.g. for emergency switch-off) or an alarm contact of the superordinated system.

In case the connection between Pin 2 and Pin 3 is interrupted by opening the contact 'AK', a complete shutdown of the circulating pump and heater is effected, and the unit enters the condition "OFF".

As long as the contact remains open, line 4 of the DIALOG-DISPLAY (LCD) flashes and displays the message „STAND-BY“.

If the contact is reclosed, the circulator returns to the stand-by status and „OFF“ is displayed.

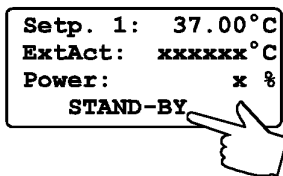

Additional tips for using the STAND-BY input:

The Stand-by function can be used in conjunction with the AUTOSTART feature (see page 28)

1. If the Autostart function is NOT turned ON, the Stand-by input should be used as described above.
2. If the Autostart function is enabled, the instrument will revert back to the original method of entering the setpoint (i.e. keypad, RS232, Analog input, etc.).

- Entering the setpoint with the keypad, for example **T1**. As described above, an bipolar shut-down is accompanied by the "STAND-BY" display and the OFF status. The programmable controller starts again when the contact is reclosed. The temperature of the bath liquid changed during the STAND-BY status.
- Entering the setpoint with the programmer (see pages 33 and 35). The display „STAND-BY“ appears. The setpoint value and the time are both held at the current value. The temperatur of the bath fluid will be held constant at this temperature. The programmer continues once the contact is reclosed.

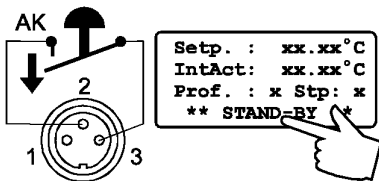

⚠ Warning: this is not an actual shutoff feature

Socket for external Pt100 sensor (19)

Pin assignment:

Pin	Signal
1	I+
2	U+
3	U-
4	I-

The shield of the connecting cable is electrically connected to the plug housing and the sensor tube.

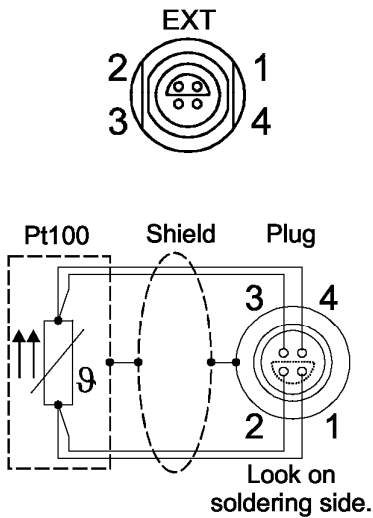

Use shielded cables only.

12. Remote control

12.1. Setup for remote control



Select the „Configuration“ submenu and select the option „Setpoint“ to define the interface (see page 28).

The interface parameters are set by selecting the submenu „Interface“ on the circulator. Normally, this is a one-time-only adjustment. (Selecting and setting menu items, see page 43.)

Factory settings:

RS232

BAUDRATE	4800 bauds
PARITY	even parity
HANDSHAKE	Protocol RTS/CTS (hardware handshake)
	Data bits 7
	Stop bit 1



Like all parameters which can be entered through the keypad, interface parameters are stored in memory even after the circulator is turned off.

12.2. Communication with a PC or a superordinated data system

Suitable terminal programs for communicating with a PC are:

- MS-Windows - TERMINAL.EXE (included with MS-Windows).
- **Easy Temp** control software – allows programming, viewing, and recording of temperature and time dependent processes when using a single JULABO instrument.
Download free of charge from www.julabo.de or Julabo Order No. 8 901 102.



If the circulator is put into remote control mode via the configuration level, the display will read "r OFF" = REMOTE STOP.

The circulator is now operated via the computer.

In general, the computer (master) sends commands to the circulator (slave). The circulator sends data (including error messages) only when the computer sends a query.

A transfer sequence consists of:

- address (RS485 interface only)
- command
- space (\Leftrightarrow Hex: 20)
- parameter (the character separating decimals in a group is the period)
- end of file (\downarrow ; Hex: 0D)

The commands are divided into **in** or **out** commands.

in commands: asking for parameters to be displayed

out commands: setting parameters

The **out** commands are valid only in remote control mode.



When the RS485 interface is used, the three-digit instrument address stands in front of each command.

(example: address Ad32 = **A032**)

Examples:

Command to set the working temperature T1 to 55.5 °C

out_sp_00 \Leftrightarrow 55.5 \downarrow

A032_out_sp_00 \Leftrightarrow 55.5 \downarrow

Command to ask for the working temperature T1:

in_sp_00 \downarrow

A032_in_sp_00 \downarrow

Response from the circulator:



55.5 \downarrow

A032_55.5 \downarrow

12.3. List of commands

When the RS485 interface is used, the instrument address stands in front of each command (Axxx_).



in-commands: Asking for parameters or temperature values to be displayed.

version	none	Number of software version (V X.xx)
status	none	Status message, error message (see page 56)
in_pv_00	none	Actual bath temperature.
in_pv_01	none	Heating power being used (%).
in_pv_02	none	Temperature value registered by the external Pt100 sensor.
in_pv_03	none	Temperature value registered by the safety sensor.
in_pv_04	1 ... 8	Liquid level indication.
in_pv_05	none	Temperature value registered by the safety sensor 1
in_pv_06	none	Temperature value registered by the safety sensor 2 (only HT60)
in_pv_07	none	Temperature value registered by the safety sensor 3 (only HT60)
in_sp_00	none	Working temperature "T"
in_sp_03	none	High temperature warning limit "  ".
in_sp_04	none	Low temperature warning limit "  ".
in_sp_05	none	Setpoint temperature of the external programmer (socket 31 - REG+E-PROG) .
in_hil_00	none	Max. cooling power (%).
in_hil_01	none	Max. heating power (%).
in_mode_01	none	Type of setpoint setting 0 = via keypad  2 = via the analog interface E-PROG
in_mode_02	none	Identification type: 0 = no identification 1 = single identification 2 = continual identification

in-commands: Asking for parameters or temperature values to be displayed.

Command	Parameter	Response of circulator
in_mode_03	none	Type of the programmer input: 0 = Voltage 0 V to 10 V 1 = Current 0 mA to 20 mA
in_mode_04	none	Internal/external temperature control: 0 = Temperature control in the circulator bath. 1 = Temperature control with external Pt100 sensor.
in_mode_05	none	Circulator in Stop/Start condition: 0 = Stop 1 = Start
in_mode_08	none	Adjusted control dynamics 0 = aperiodic 1 = standard
in_par_01	none	Time constant of the external bath.
in_par_02	none	Internal slope.
in_par_03	none	Time constant of the internal bath.
in_par_04	none	Band limiting (max. difference between the temperatures in the internal bath and external system).
in_par_06	none	Xp control parameter of the internal controller.
in_par_07	none	Tn control parameter of the internal controller.
in_par_08	none	Tv control parameter of the internal controller.
in_par_09	none	Xp control parameter of the cascade controller.
in_par_10	none	Proportional portion of the cascade controller.
in_par_11	none	Tn control parameter of the cascade controller.
in_par_12	none	Tv control parameter of the cascade controller.
in_par_13	none	Adjusted maximum internal temperature in case of cascade control
in_par_14	none	Adjusted minimum internal temperature in case of cascade control

out commands: Setting parameters or temperature values.

Command	Parameter	Response of circulator
out_mode_02	0	No identification. Temperature control by using the stored parameters.
out_mode_02	1	Single identification of controlled system after the next start.
out_mode_02	2	Continual identification of controlled system whenever a new setpoint is to be reached.
out_mode_04	0	Temperature control of internal bath.
out_mode_04	1	External control with Pt100 sensor.
out_mode_05	0	Stop the circulator = r OFF.
out_mode_05	1	Start the circulator.
out_mode_08	0	Control dynamics aperiodic
out_mode_08	1	Control dynamics standard
out_sp_00	xxx.x	Set working temperature "T".
out_sp_03	xxx.x	Set high temperature warning limit  .
out_sp_04	xxx.x	Set low temperature warning limit  .
out_hil_00	xxx	Set the desired maximum cooling power (0 % to 100 %). This adjustment is required only for proportionally controlled refrigerated circulators.
out_hil_01	xxx	Set the desired maximum heating power (10 % to 100 %).
out_par_04	xxx	Band limiting during external control. Setting the maximum difference between the temperatures in the internal bath and external system.
out_par_06	xxx	Xp control parameter of the internal controller. (**
out_par_07	xxx	Tn control parameter of the internal controller. (**
out_par_08	xxx	Tv control parameter of the internal controller. (**
out_par_09	xxx	Xp control parameter of the cascade controller. (**
out_par_10	xxx	Proportional portion of the cascade controller. (**
out_par_11	xxx	Tn control parameter of the cascade controller. (**
out_par_12	xxx	Tv control parameter of the cascade controller. (**

Remote control

out_par_13	xxx.xx	Maximum internal temperature in case of cascade control
out_par_14	xxx.xx	Minimum internal temperature in case of cascade control

```

Configuration
>Identif.    off
  Setpoint  RS232
  Autostart  off
    
```





(**

An adjustment of these values via a serial interface only makes sense, if the parameter for the identification is on >of<. If the identification is adjusted (see page 27), the control parameters Xp, Tn and Tv of a control course are determined and stored automatically. Therefore the adjusted values are overwritten.

12.4. Status messages / error messages

The circulator sends data (including error messages) only when the computer sends a query.

Status messages	Description
00 MANUAL STOP	Circulator in "OFF" state.
01 MANUAL START	Circulator in keypad control mode.
02 REMOTE STOP	Circulator in "r OFF" state.
03 REMOTE START	Circulator in remote control mode.
Error messages	Description
-01 LOW LEVEL ALARM	Low liquid level alarm
-02 COOLING UNIT ALARM	Failure of one or both temperature sensors of the C.U. cooling unit.
-03 EXCESS TEMPERATURE WARNING	High temperature warning "  ".
-04 LOW TEMPERATURE WARNING	Low temperature warning "  ".
-05 WORKING SENSOR ALARM	Working temperature sensor short-circuited or interrupted.
-06 SENSOR DIFFERENCE ALARM	Sensor difference alarm. Working temperature and safety sensors report a temperature difference of more than 100 °C.
-07 I²C-BUS ERROR	Internal error when reading or writing the I ² C bus.
-08 INVALID COMMAND	Invalid command.
-09 COMMAND NOT ALLOWED IN CURRENT OPERATING MODE	Invalid command in current operating mode.
-10 VALUE TOO SMALL	Entered value too small.

Error messages	Description
-11 VALUE TOO LARGE	Entered value too large.
-12 TEMPERATURE MEASUREMENT ALARM	Error in A/D converter.
-13 WARNING : VALUE EXCEEDS TEMPERATURE LIMITS	Value lies outside the adjusted range for the high and low temperature warning limits. But value is stored.
-14 TEMPERATURE/LEVEL ALARM	Safety temperature alarm 
-15 EXTERNAL SENSOR ALARM	External control selected, but external Pt100 sensor not connected.
-19 TEMPERATUR MEASUREMENT ALARM	Error in the measuring system of the external temperature sensor „EXT“
-26 Warning: STAND-BY PLUG IS MISSING	External stand-by contact is open. Stand-by input - see pages 48 and 49.
-31 INTERNAL COMMUNICATION ERROR	Communication between circulator HTxx and the control electronics Mx.
-33 SAFETY SENSOR 1 ALARM	Safety sensor 1: Cable of the safety sensor 1 interrupted or short-circuited.
-34 SAFETY SENSOR 2 ALARM	Safety sensor 2: Cable of the safety sensor 2 interrupted or short-circuited.
-35 SAFETY SENSOR 3 ALARM	Safety sensor 3: Cable of the safety sensor 3 interrupted or short-circuited.
-36 SENSOR COOLING ZONE ALARM	Safety sensor in the cooling zone: Cable of the safety sensor interrupted or short-circuited.
-37 INTERNAL ALARM	Safety sensor in the cooling zone: The temperature in the cooling zone has exceeded 170 °C! See „Important notice Page 13

13. Cleaning the unit



**Before cleaning the unit, disconnect the power plug from the mains socket!
Prevent humidity from entering into the circulator.**

Clean the outside of the unit using a wet cloth and low surface tension water (e.g., soap suds)..
Before applying a cleaning or decontamination method different from the one recommended by JULABO, the user has to make sure with the manufacturer, that the planned method does not damage the unit.

14. Responsibility of the operator



Take care your unit is operated only by qualified persons.

The temperature controlling i.e. immersing of test tubes, Erlenmeyer flasks or similar objects directly within the circulator constitutes normal circulator practise.

We do not know which substances are contained within these vessels. Many substances are:

- inflammable, easily ignited or explosive
- hazardous to health
- environmentally unsafe

i.e.:dangerous

You alone are responsible for the handling of these substances!

The following questions shall help to recognize possible dangers and to reduce the risks to a minimum.

- Are all tubes and electrical cables connected and installed ?
Notes:
sharp edges, hot surfaces in operation, moving machine parts, etc.
- Do dangerous steams or gases arise when heating ?
Is an exhaust needed when working ?
- What to do when a dangerous substance was spilled on or in the unit ?
Before starting to work obtain information concerning the substance and determine the method of decontamination.

15. Maintenance

The circulator is designed for continuous operation under normal conditions. Periodic maintenance is not required.

Repairs

Before asking for a service technician or returning a JULABO circulator for repair, please contact an authorized JULABO service station.

When returning the unit:

- Empty completely, remove the expansion tank, close tightly the connections with nuts and closing caps.
- Careful and appropriate packing is important.
- During transport the unit has to stand upright. Mark the packing correspondingly.

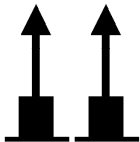

When returning a unit, take care of careful and adequate packing. JULABO is not responsible for damages that might occur from insufficient packing.



JULABO reserves the right to carry out technical modifications with repairs for providing improved performance of a unit.

16. Technical specifications

		HT60-M2	HT60-M3
Working temperature range	°C	70 ... 400	70 ... 400
Display accuracy	%	±0.5 ±1Digit	
Temperature stability	°C	±0,1 ... ±0.5	
Temperature selection via keypad		digital	
remote control via personal computer		indication on DIALOG-Display (LCD)	
Temperature indication		indication on monitor	
		Multi-Display (LED)	
		DIALOG-Display (LCD)	
Resolution	°C	0.01	
Absolute Temperature Calibration			
(ATC 1)	°C	±9.99	
(ATC 2)	°C	±9.99	
Temperature control self-optimizing		ICC - Intelligent Cascade Control, Cascade, parameter can be called-in and modified	
Heater wattage	kW	7 (3x400 V)	6 (3x208 V)
Pressure pump:			
pressure, max.	at 0 liter	1,2 bar	1,2 bar
discharge, max.	at 0 bar	18 l/min	18 l/min
Filling volume	litre	2	2
C.U.-cooling unit:			
Temperature <IntAct>	[°C]	<u>350</u> <u>250</u> <u>150</u> <u>75</u>	
Cooling capacity	[kW]	12 8 4 1	
at 2 l/min flow of cooling water			
Electrical connections:			
Computer interface		RS232 or RS485	
Programmer input		0 - 10 V / 0 - 20 mA	
Temperatur recorder outputs		Kanal 1 / 2: 0 - 10 V / Kanal 3: 0 - 20 mA / 4 - 20 mA	
Stand-by input			
External alarm device		24-0 Vdc / max. 25mA	
External measurement and controlsensor		Pt100, 4-lead technique	
Ambient temperature	°C	5 ... 40	5 ... 40
Mains power connection ±10 %	V/ Hz	400 / 50 / 3 Phases	208 / 60 / 3 Phases
Total power consumption	kW	7,45	6,45
Overall dimensions (WxDxH) M2 / M3	cm	25x25x18	
Overall dimensions (WxDxH) HT60	cm	23x23x58	
Overall dimensions (WxDxH) CU	cm	23x18x28	
Weight Mx / HT60 / CU	kg	18	

All measurements have been carried out at:
 rated voltage and frequency ambient temperature: 20 °C
 Technical changes without prior notification reserved.

Technical specifications

Cooling water:

Cooling water pressure (IN / OUT)	max.	4,5 bar
Difference pressure (IN - OUT)		2 to 4,5 bar
Rate of flow	typical	2 l/min
Cooling water temperature		>5 °C and <20 °C

Quality of cooling water:

pH at 25 °C		7 to 8.5
Suspended matter		<30 mg/l
Size of suspended matter	max.	0.1 mm
Growth of algae		not permissible

Safety installations according to IEC 61010-2-010:

Excess temperature protection		adjustable from 0 °C ... 420 °C
Low liquid level protection		float switch
Liquid level indication		optical 8-graded
Classification according to DIN 12876-1		class III FL

Supplementary safety installations

High temperature warning function		optical + audible (in intervals)
Low temperature warning function		optical + audible (in intervals)
Supervision of the working sensor		plausibility control
Reciprocal sensor monitoring between working and safety sensors		difference >100 °C
Alarm indication		optical + audible (permanent)

Environment:

Use only indoor.

Altitude up to 2000 m - normal zero.

Ambient temperature: +5 ... +40 °C (for storage and transportation)

Air humidity acc. DIN EN 61 010, part 1:

Max. rel. humidity 80 % for temperatures up to +31 °C,

linear decrease down to 50 % rel. humidity at a temperature of +40 °C

Protection class: IP 21 acc. EN 60 529

Power supply: acc. to class 1, VDE 0106 T1

not for use in explosive atmosphere

Max. mains fluctuation of ±10 % are permissible.

Overvoltage category II

Pollution degree 2

17. EC Declaration of Conformity



The following unit complies with the essential safety requirements outlined by the EC Directives concerning the guidelines for electromagnetic compatibility (89/336/EEC) and for the low voltage regulations (73/23/EEC).

High Temperature Circulator

HT60-M2, HT60-M3

C.U.-cooling unit

This unit is manufactured in compliance with the following guidelines

electrical equipment for control technology and laboratory application –
EMC requirements outlined by

EN 61326

safety regulation for electrical devices for measuring, control and
laboratory application specified by

EN 61010

Julabo

Julabo Labortechnik GmbH
Eisenbahnstr. 45
D-77960 Seelbach / Germany

A handwritten signature in black ink, appearing to read 'G. Juchheim', written over a light gray rectangular background.

G. Juchheim, Managing Director

18. Warranty conditions

JULABO Labortechnik GmbH warrants its products against defects in material or in workmanship, when used under appropriate conditions and in accordance with appropriate operating instructions

for a period of ONE YEAR.

Extension of the warranty period – free of charge



With the '1PLUS warranty' the user receives a free of charge extension to the warranty of up to 24 months, limited to a maximum of 10 000 working hours.

To apply for this extended warranty the user must register the unit on the JULABO web site www.julabo.de, indicating the serial no. The extended warranty will apply from the date of JULABO Labortechnik GmbH's original invoice.

JULABO Labortechnik GmbH reserves the right to decide the validity of any warranty claim. In case of faults arising either due to faulty materials or workmanship, parts will be repaired or replaced free of charge, or a new replacement unit will be supplied.

Any other compensation claims are excluded from this guarantee.