

English

Operating manual

Recirculating coolers

FC600	FC600S	FCW600	FCW600S
FC1200	FC1200S	FCW1200	FCW1200S
FC1600	FC1600S	FCW1600	FCW1600S

air-cooled

water cooled

Distributed by:



ADVANCED APPLIED TECHNOLOGIES

Contact Us:

Irl Ph: 01 4523432

UK Ph: 08452 30 40 30

Web: www.carlstuart.com

Email: info@carlstuart.com

Julabo

JULABO Labortechnik GmbH

Eisenbahnstraße 45

D-77960 Seelbach / Germany

+49-7823 / 51-0

+49-7823 / 2491

info@julabo.de

www.julabo.de

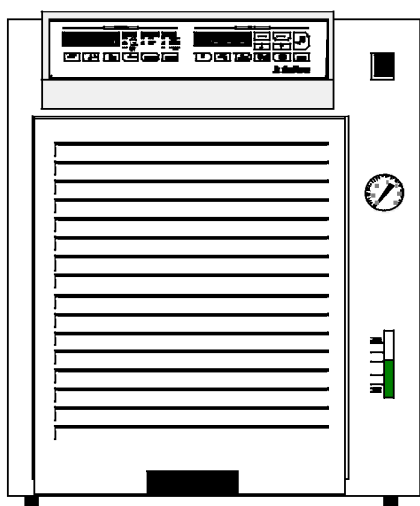

1.951.4802BE3 07/04
Software version n 9.0

Congratulations!

You have made an excellent choice.

Julabo thanks you for the trust you have placed in us.

This operating manual has been designed to help you gain an understanding of the principles of operating and possibilities of our circulators. For optimum utilization of all functions, we recommend that you thoroughly study this manual prior to beginning operation.

Safety Warnings

Take care your unit is operated only by qualified persons.

Make sure you read and understand all instructions and safety precautions listed in this manual before installing or operating your unit. If you have any questions concerning the operation of your unit or the information in this manual, contact JULABO.

Performance of installation, operation, or maintenance procedures other than those described in this manual may result in a hazardous situation and may void the manufacturer's warranty.

Transport the unit with care. Sudden jolts or drops may cause damages in the interior of the unit.

Observe all warning labels.

Never remove warning labels.

Never operate damaged or leaking equipment.

Never operate the unit without bath fluid in the bath.

Always turn off the unit and disconnect the mains cable from the power source before performing any service or maintenance procedures, or before moving the unit.

Always empty the bath before moving the unit.

Never operate equipment with damaged mains power cables.

Refer service and repairs to a qualified technician.



In addition to the safety warnings listed above, warnings are posted throughout the manual. These warnings are designated by an exclamation mark inside an equilateral triangle. Read and follow these important instructions. Failure to observe these instructions can result in permanent damage to the unit, significant property damage, personal injury or death.

Table of Contents

1. Operating controls and functional elements.....	4
2. Quality Management System.....	7
3. Unpacking and checking.....	7
4. Description.....	7
5. Operation.....	8
5.1. Preparations.....	8
5.2. Bath liquids.....	9
5.3. Tubing.....	9
5.4. Power connection.....	9
5.5. Filling.....	10
5.6. Draining.....	11
5.7. Return flow safety device.....	12
6. Manual operation.....	13
6.1. Switching on.....	13
6.2. Start.....	13
6.3. Setting the setpoint temperatures.....	15
6.3.1. Setting the temperature.....	15
6.3.2. Setting the control ratio for feed/return flow temperature.....	16
6.3.3. Setting the safety temperatures.....	17
6.3.4. Low liquid level protection.....	17
6.4. PID control parameters.....	18
7. Trouble shooting guide.....	20
7.1. Other error messages.....	21
8. Safety recommendations.....	21
9. Electrical connections.....	22
10. Remote control.....	24
10.1. Communication with a PC or data system.....	24
10.2. List of commands.....	25
10.3. Status messages.....	25
10.4. Error messages.....	26
11. Menu functions.....	27
11.1. Selecting/exiting the configuration level.....	27
11.2. Setting the parameters.....	27
11.3. Adjustable parameters.....	28
12. Maintenance.....	29
13. Cleaning the unit.....	29
14. Technical specifications.....	30
15. EC Declaration of Conformity.....	33
16. Warranty conditions.....	34

1. Operating controls and functional elements

1. Mains power switch, illuminated

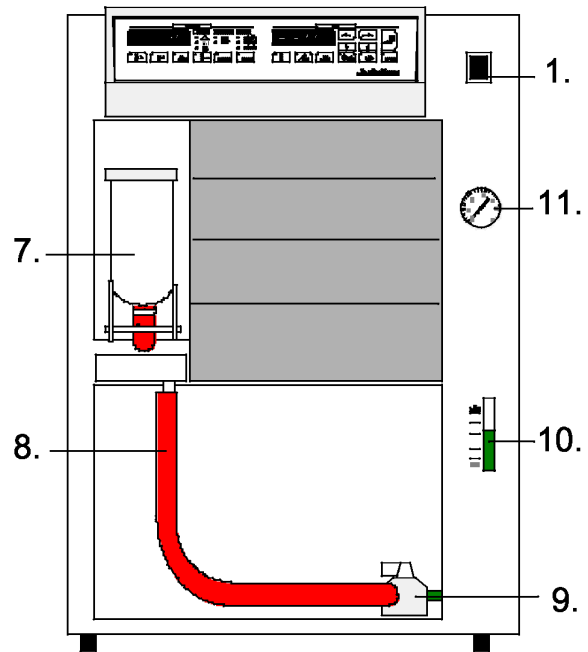

- 7. Filling funnel
- 8. Drain tubing
- 9. Drain tap
- 10. Filling level indication
- 11. Pump pressure gauge



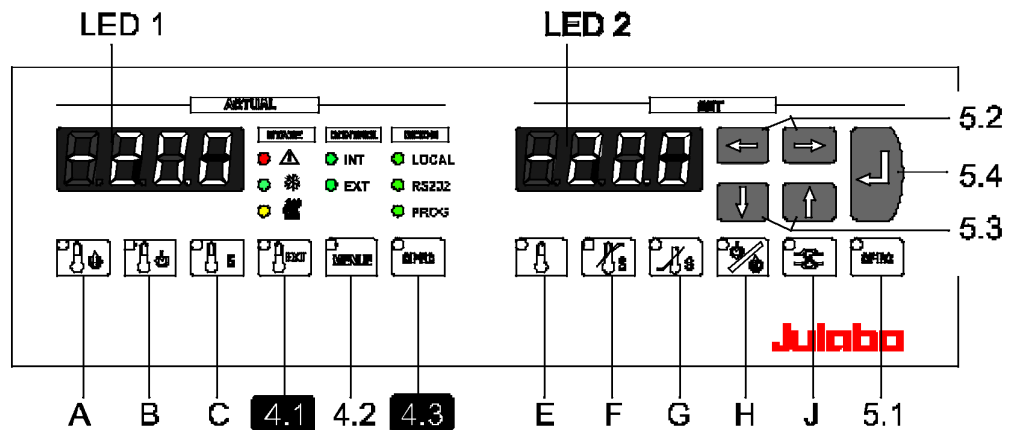

2. MULTI-Display temperature indication  (LED 1 + LED 2)





3. Indicator lights

- | | | |
|---|----------------|--------------------------------|
| STATE | CONTROL | MODE |
| ●  Alarm | ● INT Temp. | ● LOCAL = Keypad control mode |
| ●  Heating | ○ EXT Control | ● RS 232 = Remote control mode |
| ●  Cooling | | ○ PROG |





4. Keys for actual values ACTUAL (LED 1)

- A  Key - Indication of feed temperature
- B  Key - Indication of return temperature
- C  Key - Indication of safety temperature

4.2  The "MENU" key is not required for normal operating

4.1  The keys "EXT" and "SPEC" are not required for
4.3 Fehler! Es ist nicht möglich, durch die Bearbeitung von Feldfunktionen Objekte zu erstellen. this model version.



5. Keys for setpoint values SET (LED 2)

- E  Key - Indication or setting of working temperature
- F  Key - Indication or setting of high temperature
- G  Key - Indication or setting of low temperature
- H  Key - Indication or setting of control ratio for feed/return flow temperature

J  Key - Circulating pump On/Off

5.1  Key - "SPEC" - PID control parameters

5.2   Cursors left/right

5.3   Edit keys (increase/decrease setting)

5.4  Enter key (start, store)

6. Electrical connectors

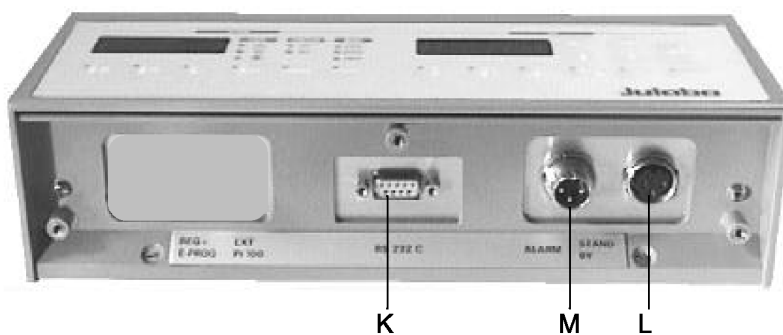

- K Interface RS 232
- M Alarm output (for external alarm signal)
- L Stand-by input conforming to NAMUR recommendations (external emergency switch-off)

Rear

- 12.1 Pump connector: Feed
- 12.2 Pump connector: Return
- 13. Overflow port for bath tank
- 14. Connectors for solenoid valves
- 15. Mains power cable with plug

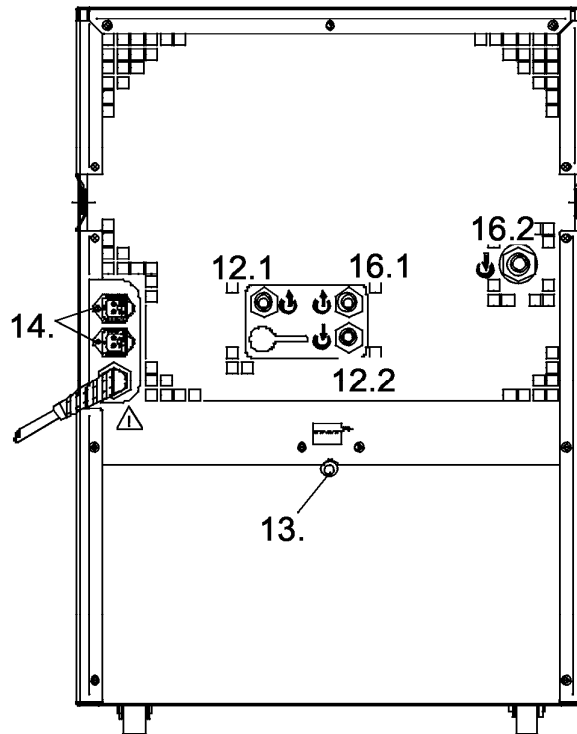

Only for water cooled models:

- 16.1 Cooling water OUTLET
- 16.2 Cooling water INLET

2. Quality Management System



The JULABO Quality Management System:

Development, production and distribution of temperature application instruments for research and industries conform to the requirements according to DIN EN ISO 9001:1994-08.

Certificate Registration No. QA 051004008.

3. Unpacking and checking

Unpack the unit and accessories and check for damages incurred during transit. These should be reported to the responsible carrier, railway, or postal authority to enable a damage report to be made.

4. Description

The recirculating cooler consists of

- control unit with splash-proof keypad (microprocessor technology)
- cooling compressor
- heater
- heating/cooling bath and recirculating pump

The electronics comprises two microprocessors that provide reciprocal monitoring via sensors for the working and safety circuit.

The actual and setpoint temperatures are permanently visible on the MULTI-DISPLAY (LED 1 + LED 2) and thus may be easily compared.

The bath tank is located in the lower part of the unit. The cooling machine draws heat from the bath liquid via the cooling coil (evaporator). If the setpoint lies above the ambient temperature, the integrated heater produces more heat.

The integrated circulating pump ensures constant conditions for the external cooling loop and provides a good circulation of the liquid in the bath tank.

The unit provides analog electrical connections and a serial interface.

Safety installations: High temperature and low temperature limits, both adjustable via the MULTI-DISPLAY, as well as low liquid level protection.



This recirculating cooler conforms to the safety requirements specified by DIN 12 876 as well as DIN 58 966, the guideline for first voltage range EN 61010.

5. Operation

5.1. Preparations

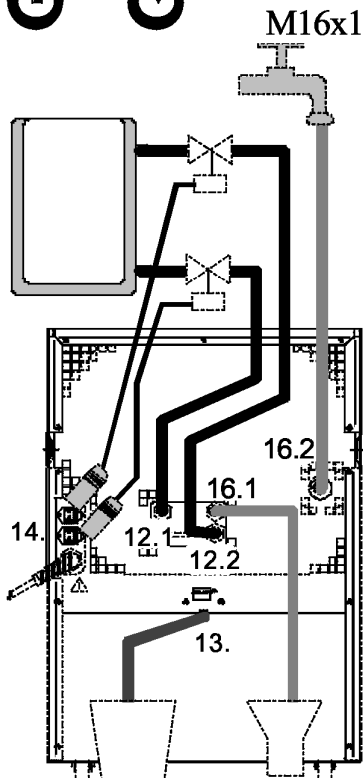
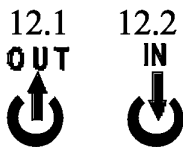
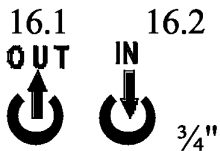

- Place the unit in an upright position.
- Keep at least 20 cm of open space on the front and rear venting grids.
- Do not set up the unit in the immediate vicinity of heat sources and do not expose to sun light.
- Before operating the unit after transport, wait about one hour after setting it up. This will allow any oil that has accumulated laterally during transport to flow back down thus ensuring maximum cooling performance of the compressor.
- **Only for water cooled models:**
Ensure circulation of cooling water by connecting the tubing to cooling water inlet (16.2.) and outlet (16.1) on the rear of the recirculating cooler.
Cooling water temperature: <20 °C
Quality of cooling water see page 32.



- Connect the tubings for cooling the external system to the pump connectors for feed and return (12.1. and 12.2.) on the rear of the recirculating cooler.

 Use tube clamps to prevent slipping.

- In case the system to be cooled is located at a higher level than the recirculating cooler, take note of bath liquid flowing back when the unit is switched off. Should the filling volume of the bath tank not be sufficient, prevent the liquid from flowing back by using solenoid valves or shut-off valves (see page 12).
- If necessary, connect a tube to the overflow port (13.) for controlled draining of the liquid.

5.2. Bath liquids

Bath liquid	Temperature range
water	5 °C to 80 °C
water/glycol mixture	-20 °C to 30 °C

	<p><u>Do not use alcohols.</u> No liability for use of other bath liquids!</p> <p style="text-align: center;">  No liability for use of water. Danger of freezing. </p>
---	--

5.3. Tubing

	Maximum pressure
Chloroprene tubing	0.5 bar
Textile reinforced tubing	4.5 bar

5.4. Power connection

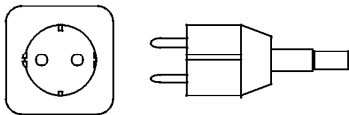

- Connect the unit to grounded power outlets only!
- Check to make sure that the line voltage matches the supply voltage specified on the identification plate. Deviations of $\pm 10\%$ are permissible.

	<p>We disclaim all liability for damage caused by incorrect line voltages!</p>
---	---

5.5. Filling

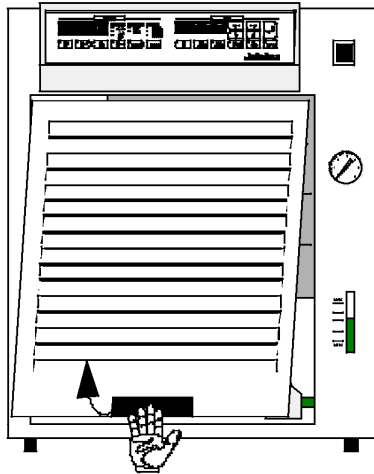

- Connect the tubing from the external system to the pump connectors and check for leaks.
- Hold the venting grid, pull out and remove.
- Check to make sure that the drain tap (9.) is closed.
- Move the filling funnel (7.) to the front and remove cap.
- Fill the bath tank and take care of the filling level (10.).

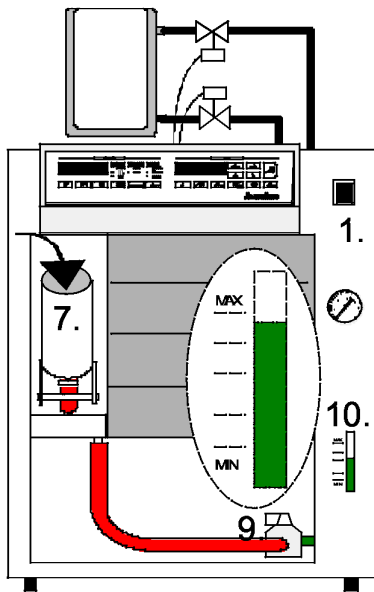

Activating the circulating pump with simultaneous filling of the external system.

- Turn the mains switch (1.) on (Switching on - see page 13).
- Press the key "J"  to activate the pump for filling the cooling loop for the external system. In case return flow safety devices (solenoid valves) are connected to the connectors (14.) those will simultaneously be opened.
- Check the filling level (10.) and keep on filling the bath liquid using the funnel until you get within the level marked "MAX".
- Close the filling funnel and move it to the back.
- Replace the venting grid.

5.6. Draining

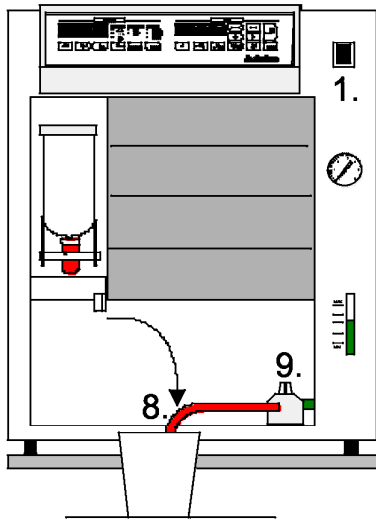

- Turn the mains switch (1.) off.
- Hold the venting grid, pull out and remove.
- Take the drain tubing (8.) out of the holder and hold it into a pail.
- Open the drain tap (9.) and empty the unit completely.
- Close the drain tap and replace the drain tubing into the holder.
- Replace the venting grid.

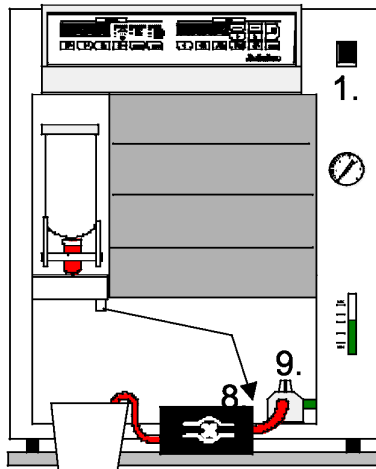

In case the recirculating cooler is placed on the floor, the unit may be drained using a suction pump unit.

- Connect the drain tubing (8.) to the suction pump unit.
- Open the drain tap (9.).
- Switch the pump on and fully empty the unit.



For safety reasons, empty the bath liquid at temperatures between 10 °C and 30 °C.

5.7. Return flow safety device

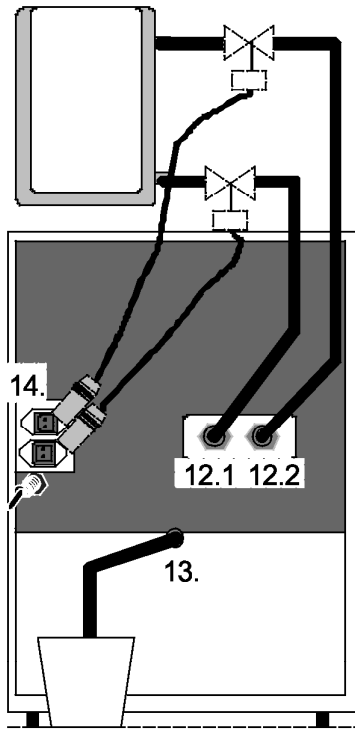

In case the system to be cooled is located at a higher level than the recirculating cooler, prevent the bath liquid from flowing back when the unit is turned off.

For this purpose, connect electrical solenoid valves or mechanical shut-off valves to the connectors for feed and return (12.1. and 12.2.).

The solenoid valves are electrically connected to the connectors (14.). As soon as the recirculating cooler is switched off, the valves close automatically. (Filling - see page 10)

Order No. 8 980 701 Solenoid valve (230 V)
(2 pcs. necessary)

If necessary, connect a tube to the overflow port (13.) for controlled draining of the liquid.

6. Manual operation

6.1. Switching on

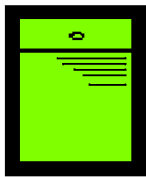

Turn on the mains power switch (1.).
An illuminated switch indicates the unit is on.

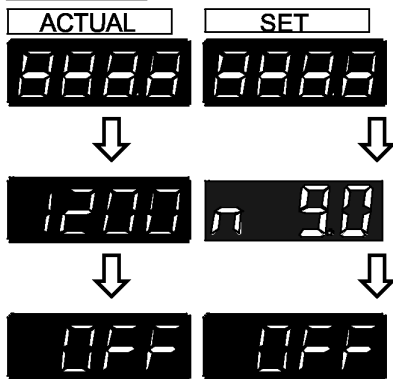

The unit performs a self-test. All segments of the 4-digit MULTI-DISPLAY (LED 1 + LED 2) and all indicator lights will illuminate.

Then the model designation and software version appear on the MULTI-DISPLAY for about 3 seconds
(Example: FC"1200", "n 9.0").

The display "OFF" indicates the recirculating cooler is ready to operate (rOFF - see page 24).

6.2. Start



- Press the Enter key (5.4) for about 2 seconds.

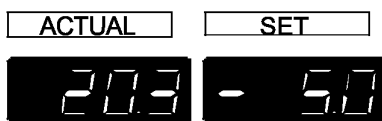

The MULTI-DISPLAY (LED 1) indicates the actual feed temperature (example: 20.3 °C).

The MULTI-DISPLAY (LED 2) indicates the setpoint for the bath temperature (example: -5.0 °C).

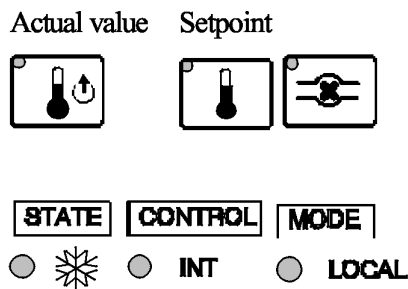

The indicator lights signal the actual operating mode.

- Display Feed temperature (A)
- Display Setpoint bath temperature (E)
- Circulating pump On (J)
- Status Cooling on ❄️
- Control Internal temperature control
- Mode Keypad control mode

NOTE:

The recirculating cooler has been configured and supplied by JULABO according to N.A.M.U.R. recommendations. This means for the start mode, that the unit must enter a safe operating state after a power failure (non-automatic start mode). This safe operating state is indicated by „OFF“ or „rOFF“, resp. on the MULTI-DISPLAY (LED). A complete shutdown of the main functional elements such as heater and circulation pump is effected simultaneously.

Should such a safety standard not be required, the AUTOSTART function (automatic start mode) may be activated, thus allowing the start of the recirculating cooler directly by pressing the mains power switch or using a timer.

Automatic / non-automatic start mode

Activating/deactivating AUTOSTART

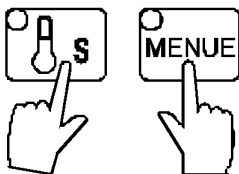
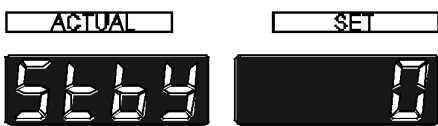
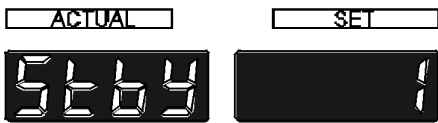
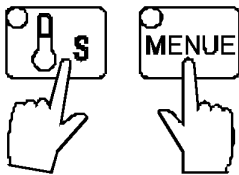
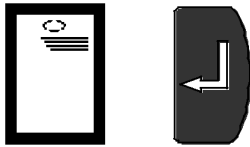

1. Turn on the recirculating cooler with the mains power switch and press the Enter key to start operation.

2. **Simultaneously** press the safety temperature key (C) and the MENU key (4.2) to enter the setting mode.

Press the edit key  to select the parameter on the MULTI-DISPLAY (LED2).

„1“ - AUTOSTART off.

„0“ - AUTOSTART on.

Press the Enter key  to store the parameter.

3. **Simultaneously** press the safety temperature key (C) and the MENU key (4.2) to exit the setting mode.

The AUTOSTART function (automatic start mode) allows the start of the recirculating cooler directly by pressing the mains power switch or using a timer.



Warning: For supervised or unsupervised operation with the AUTOSTART function, avoid any hazardous situation to persons or property. The recirculating cooler does no longer conform to N.A.M.U.R. recommendations.

Take care you fully observe the safety and warning functions of the recirculating cooler.

6.3. Setting the setpoint temperatures

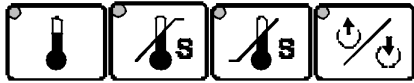

Set the setpoints before or after starting the unit.

Press the setpoint keys (E, F, G, H) to set a value and press the Enter key to store the value.

The values will stay in memory when the recirculating cooler is powered down.

6.3.1. Setting the temperature

Example: Setting the bath temperature

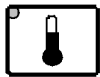

- 1 Press the setpoint key

The indicator light **blinks** and the value previously set appears on the MULTI-DISPLAY (LED) (example: -10.8 °C)..

- 2 Use the cursor keys to move left or right on the display until the numeral you wish to change is blinking.

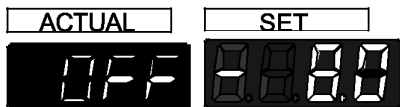

- 3 Use the increase/decrease arrows to change the selected numeral (-, 0, 1, 2, 3, ... 9).

- 4 Press enter to store the selected value (example: -8.0 °C).

6.3.2. Setting the control ratio for feed/return flow temperature

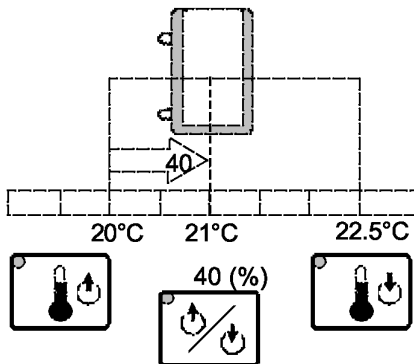
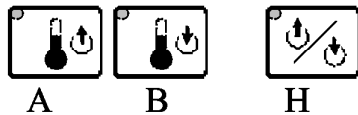
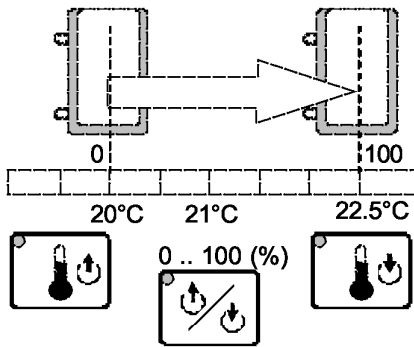
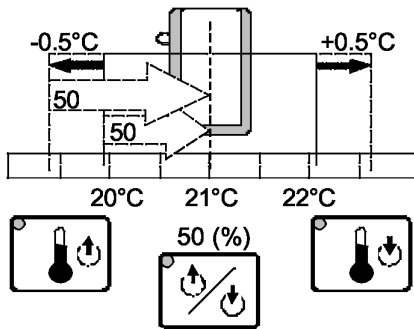

In respect to the values for feed and return temperature and the factor set with the key "H" an almost constant temperature value may be maintained in the external system. The control function quickly responds to changing conditions (ambient temperature, reaction heat), and thus spares the use of an external sensor.

The control ratio for feed and return flow temperature is factory preset to "50:50".

For enabling optimum control performance for asymmetric experiments, this ratio may be adjusted from 0 to 100 %.

- 0 % control with full respect to feed temperature
- 100 % control with full respect to return temperature.

Setting:

- 1 Press the key .
Follow the instructions under section 6.3.1. page 15
- 2
- 3
- 4

Calculation example:

Look up the values for control ratio, actual feed and return temperatures on the display by pressing the keys (A, B, H).

Example:

$$\begin{aligned} \vartheta_{\text{RETURN}} &= 22.5 \text{ }^\circ\text{C} \\ \vartheta_{\text{FEED}} &= 20 \text{ }^\circ\text{C} \\ \text{factor} &= 40 \text{ \%} \end{aligned}$$

Formula for calculating the actual value:

$$J_{\text{ACT}} = J_{\text{RETURN}} * \frac{\text{factor}}{100} + J_{\text{FEED}} * \frac{(100 - \text{factor})}{100}$$

$$J_{\text{ACT}} = 22.5^\circ\text{C} \frac{40}{100} + 20^\circ\text{C} \frac{(100 - 40)}{100}$$

$$J_{\text{ACT}} = 21^\circ\text{C}$$

6.3.3. Setting the safety temperatures

This safety function is **independent** of the control circuit.

- ① Press the desired setpoint key (F, G).
Follow the instructions under section 6.3.1.
page 15

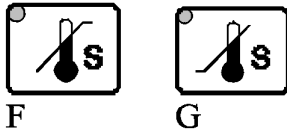

- ②
- ③
- ④



Recommendation:

Set the high temperature limit at least 5 K above the actual bath temperature.

Set the low temperature limit at least 5 K below the setpoint.

When the temperature of the bath liquid reaches the limits of the safety values, a complete shutdown of the circulating pump, heater and cooling compressor is effected.

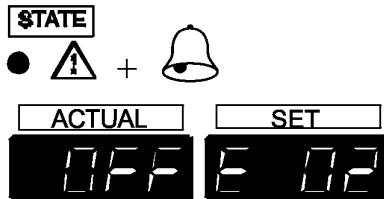

The alarm light illuminates and an audible signal is triggered. An error message appears on the MULTI-DISPLAY (LED 2)
(see page 20).

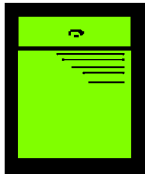

Turn the mains switch (1.) off and on. The alarm state is cancelled and the circulator is put back into operation.
(Switching on - see page 13).

6.3.4. Low liquid level protection

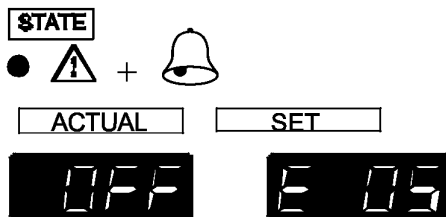

As soon as the bath liquid falls below the "MIN" level (10.), a complete shutdown of the circulating pump, heater, and cooling compressor is effected. The alarm light illuminates and an audible signal is triggered. An error message appears on the MULTI-DISPLAY (LED 2)
(see page 20).

6.4. PID control parameters

CONTROL

● INT

● EXT

For internal and external control two separate parameter sets are available.

The PID control parameters can be adapted to the requirements of the controlled member.

The values are preserved after switching off the recirculating cooler.



- The control parameters are indicated by operating the key  (5.1).

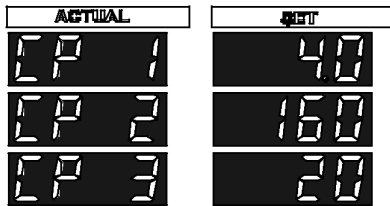







Indications in case of internal control **CONTROL** INT:

Parameter		Setting range
CP 1	Xp (example 4.0 K).	0.1 ... 100 K
CP 2	Tn (example 160 s).	1 ... 9999 s
CP 3	Tv (example 20 s).	0 ... 500 s

Each indicated control parameter can be optimized manually .

Setting:



- Operate the key  as often until the desired control parameter is indicated. Example: CP3
- Use the cursor keys   to move left or right on the display until the numeral you wish to change is blinking.
- Use the increase/decrease arrows   to change the selected numeral (-, 0, 1, 2, 3, ... 9).
- Press enter  to store the selected value

Optimization instructions for the PID control parameters:

The heat-up curve reveals inappropriate control settings

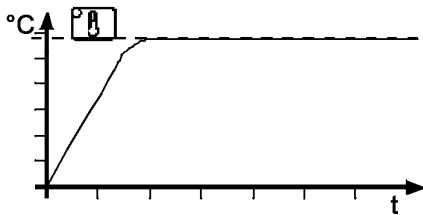

optimum setting

Inappropriate settings may produce the following heat-up curves:

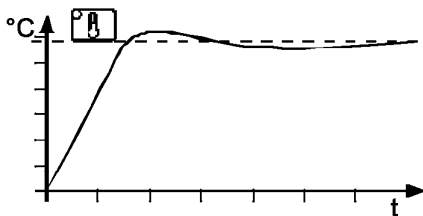

Xp too low

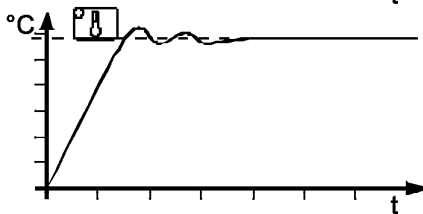

Tv/Tn too low

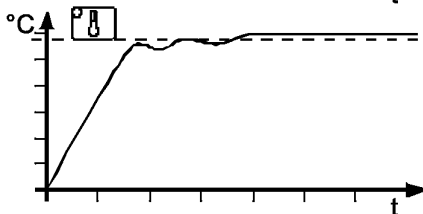

Xp
or
Tv too high

7. Trouble shooting guide

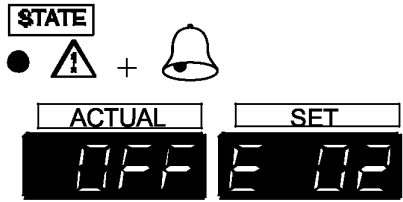

Whenever the microprocessor electronics registers a failure, an alarm is triggered and a **complete shutdown** is performed.

The alarm light illuminates and an audible signal is triggered. An error message appears on the MULTI-DISPLAY (LED 2).



Internal error



High temperature alarm 



Low temperature alarm 



The values reported by the safety sensor and the sensor in the feed connector differ by more than 25 K (defective sensor).



Low liquid level alarm



} Internal errors



Pump disconnection



Compressor disconnection



Heater disconnection

Turn the unit off with the mains switch (1), and eliminate the malfunction. If the unit cannot be returned to operation, contact an authorized service station.

7.1. Other error messages

ACTUAL

SET



Incorrect/invalid entry. Value too small or too large, or function not available.

Under menu item E_Sb the parameter is set to 1, and the connection between Pin 2 and Pin 3 of the stand-by connector is interrupted (see page 22).

8. Safety recommendations

Follow the safety recommendations to prevent damage to persons or property. Further, the valid safety instructions for working places must be followed.



- Connect the unit to grounded power outlets only.
- Check to make sure that the line voltage matches the supply voltage specified on the identification plate.
- Make sure there is enough ventilation for the unit.
- Set the safety values for high temperature and low temperature.
- Employ suitable connecting tubing. Avoid sharp bends.
- Make sure that the tubing is securely attached.
- Fill or empty the bath liquid only at temperatures between 10 °C and 30 °C.
- Do not close the overflow port.
- Take account of the thermal expansion of bath liquid during heating.
- Only use the recommended bath liquids (see page 9).
Do not use alcohols (explosion danger)!

9. Electrical connections

Stand-by input (L)

Pin assignment:	Pin	Signal
	1	not used
	2	5 V / DC
	3	0 V

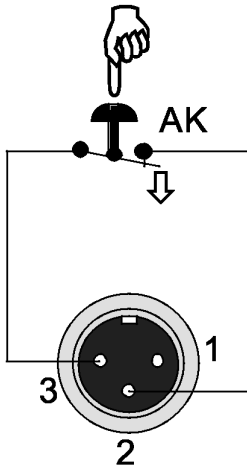

Activate the stand-by input:

Under menu item E_Sb, set the parameter to 1 (see page 28).

Connect an external contact 'AK' (e.g. for emergency switch-off) or an alarm contact of the superordinated application system.

In case the connection between Pin 2 and Pin 3 is interrupted by opening the contact 'AK', a complete shutdown of the circulating pump, heater and cooling compressor is effected, and the unit enters the condition "stand-by". The message "E_Sb" appears on the MULTI-Display (LED2) (see page 21).

•



Use shielded cables only.

Alarm output (M)

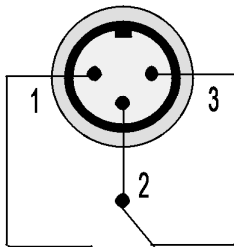

This potential-free change-over contact is activated in case of an alarm.

Pins 2 and 3 are connected under the following conditions:

- alarm
- status "OFF" and "rOFF"
- mains switch "off"

Switching capacity max. 30 W / 40 VA

Switching voltage max. 125 V~/-

Switching current max. 1 A



Use shielded cables only.

Serial interface (K)

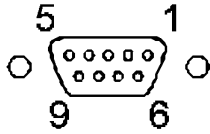

This interface is a 9-pole connector:

Pin 2 RxD Receive Data



Pin 3 TxD Transmit Data

Pin 5 Gnd

Pin 7 RTS Request to send

Pin 8 CTS Clear to send

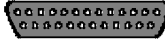
Interface correspondence:

Circulator	Computer	Circulator	Computer	
				
9-pole	25-pole	9-pole	9-pole	
Pin 2 RxD	↔	Pin 2 RxD	↔	Pin 3 TxD
Pin 3 TxD	↔	Pin 3 TxD	↔	Pin 2 RxD
Pin 5 GND	↔	Pin 5 GND	↔	Pin 5 GND
Pin 7 RTS	↔	Pin 7 RTS	↔	Pin 8 CTS
Pin 8 CTS	↔	Pin 8 CTS	↔	Pin 7 RTS



Use shielded cables only.

Return flow safety device

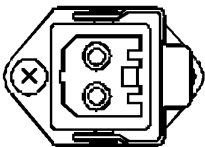

Control connector for solenoid valves (14.)
(line voltage: 230 V).

10. Remote control

10.1. Communication with a PC or data system



For remote control, under the menu item **OP** (Operating mode) set the parameter to 1. The message "rOFF" appears on the display. In general, the computer (master) sends commands to the recirculating cooler (slave). The recirculating cooler sends data (including error messages) only when the computer asks for it.

A transfer sequence consists of:

- command
- space (↔; Hex: 20)
- parameter (the character separating decimals in a group is the period)
- end of file (↵; Hex: 0D)

The commands are divided into **in** or **out** commands.

in commands: asking for parameters to be displayed

out commands: setting parameters



The **out** commands are valid only in remote control mode.

Examples:

- Command to set the setpoint to 5.5 °C:
out_sp_00 ↔ 5.5;
- Command to ask for the setpoint:
in_sp_00;
- Response from the recirculating cooler:
;

10.2. List of commands

Command	Parameter	Response of recirculating cooler
version	no	Number of software version
status	no	Status message (see below)
out_mode_04	0	Set control mode via PC
out_mode_04	1	Set control mode via programmer input (O)
in_mode_04	no	Ask for actual control mode
out_mode_05	0	Stop the recirculating cooler = rOFF
out_mode_05	1	Start the recirculating cooler
in_mode_05	no	Ask for actual condition (Start/Stop)
out_sp_00	xx.x	Set working temperature value
in_sp_00	no	Ask for working temperature value
in_sp_01	no	Ask for high temperature value
in_sp_02	no	Ask for low temperature value
out_sp_03	xxx	Set control ratio for feed/return flow temperature
in_sp_03	no	Ask for actual control ratio
in_pv_00	no	Ask for actual feed temperature
in_pv_01	no	Ask for actual temperature of external sensor
in_pv_02	no	Ask for actual heater capacity
in_pv_03	no	Ask for actual return temperature
in_pv_04	no	Ask for actual safety temperature
out_par_06	x:x	Control parameter Xp of the internal controller
in_par_06	x:x	out = set; in = ask
out_par_07	xx.xx	Control parameter Tn of the internal controller
in_par_07	xx.xx	out = set; in = ask
out_par_08	xx.xx	Control parameter Tv of the internal controller
in_par_08	xx.xx	out = set; in = ask

10.3. Status messages

Message	Description - Recirculating cooler ...
00 MANUAL STOP	... in condition "OFF" (LOCAL)
01 MANUAL START	... in keypad control mode (LOCAL)
02 REMOTE STOP	... in condition "rOFF" (RS 232)
04 REMOTE START	... in remote control mode (RS 232)

10.4. Error messages

Message	Description
-01 WORKING PROCESSOR ALARM	Internal error
-02 EXCESS TEMPERATURE ALARM	High temperature alarm
-03 LOW TEMPERATURE ALARM	Low temperature alarm
-04 SENSOR DIFFERENCE ALARM	Sensor difference alarm $ \vartheta_{\text{Safety sensor}} - \vartheta_{\text{Feed}} > 25^{\circ}\text{C}$
-05 LOW LEVEL ALARM	Low liquid level alarm
-06 PROCESSOR COMMUNICATION ERROR	Internal error
-07 I2C-BUS WRITE ERROR	Internal error
-08 I2C-BUS READ ERROR	Internal error
-09 I2C-BUS READ/WRITE ERROR	Internal error
-10 COMMAND NOT ALLOWED IN CURRENT OPERATING MODE	Invalid command in current operating mode
-12 VALUE TOO SMALL	Value too small
-13 VALUE TOO LARGE	Value too large
-14 INVALID COMMAND	Invalid command
-15 WARNING: STAND-BY PLUG IS MISSING	External stand-by plug is missing (see page 22)
-16 WARNING: VALUE EXCEEDS TEMPERATURE LIMITS	Value lies outside the permissible range for the safety temperature limits. But value is stored anyway.
-17 PUMP ERROR	Pump disconnection
-18 COMPRESSOR ERROR	Compressor disconnection
-19 HEATER TRIAC SHORTED	Heater disconnection

11. Menu functions

Set the parameters for the recirculating cooler via the configuration or calibration level.

11.1. Selecting/exiting the configuration level

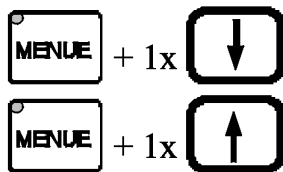

Simultaneously press the "MENUE" key (4.2) and the edit key "↓" to select the configuration level or the edit key "↑" to exit the configuration level.



Select the menu items of the configuration level one by one by pressing simultaneously the menu key and one of the cursors.

11.2. Setting the parameters

Example: Baud rate

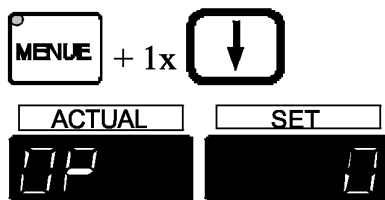

① Select the configuration level by pressing the keys simultaneously.

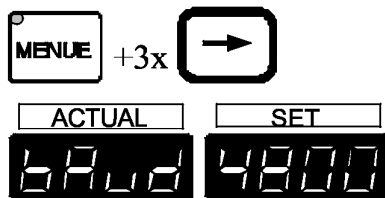

② Select the menu item by pressing simultaneously the menu key and one of the cursors. (example: press the cursor key "→" 3 times).



③ Set the baud rate (4800 Bauds) with the edit keys ("↑" or "↓").



④ Press the enter key to store the new parameter.

11.3. Adjustable parameters

Set the parameters for the following menu items in the configuration level:

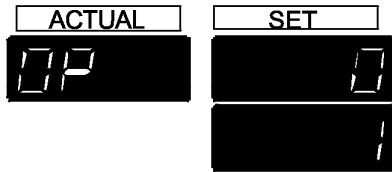

OP - Operating mode

- 0 = Keypad control
- 1 = Remote control via RS 232

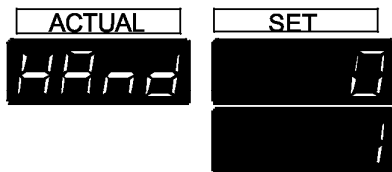

Hand - Handshake of the serial interface

- 0 = XOn/XOff, software handshake
- 1 = RTS/CTS, hardware handshake *

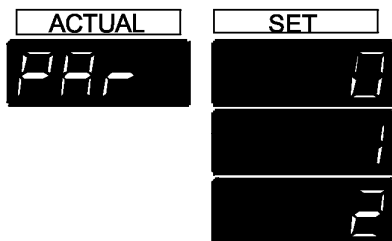

Par - Parity bits of the serial interface

- 0 = no
- 1 = odd
- 2 = even *

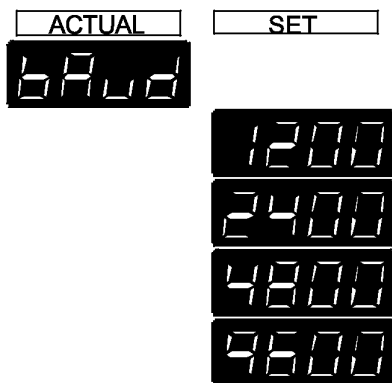

bAud - Baud rate of the serial interface

- 1200 Bauds
- 2400 Bauds
- 4800 Bauds*
- 9600 Bauds



E_Sb - External stand-by for emergency switch-off

- 0 = stand-by input is ignored *
- 1 = stand-by input is active
(Stand-by input - see page 22)

(* factory setting)

12. Maintenance

The recirculating cooler is designed for reliable continuous operation, and requires no maintenance.

13. Cleaning the unit



Before cleaning the unit, disconnect the power plug from the mains socket.

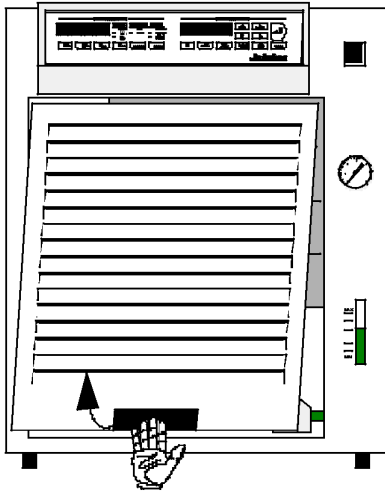

In order to maintain a good condition of the cooling compressor, the condenser should be checked for contamination in regular intervals.

- Switch the unit off, disconnect the power plug.
- Hold the venting grid, pull out and remove.
- Remove the dirt from the condenser with a vacuum cleaner.
- Replace the venting grid.
- The unit is ready to operate again.

Clean the outside of the unit using a wet cloth.



Prevent humidity from entering into the recirculating cooler.

14. Technical specifications

		FCW600	FCW600S
Working temperature range	°C	-20 ... 80	-10 ... 80
Cooling capacity (water-glycol)	°C	<u>20</u> <u>5</u> <u>-10</u>	<u>20</u> <u>5</u> <u>-10</u>
	W	600 400 210	500 300 100
Refrigerant		R134a	
Heater capacity	W	1200	
Pump capacity:			
Pressure max.	bar	0.5	1.2
Flow rate max.	l/min	20 / 14	22 / 15
with tubing connections	mm Ø	13,5/9,5	13,5/9,5
Pump connections		M16x1	M16x1
Noise level, 1 m distance	dBA	51	54
Filling volume	l	6 ... 8	
Dimensions (WxLxH)	mm	360 x 540 x 490	
Ambient temperature	°C	5 ... 40	
Shipping weight	kg	43	44
Mains power connection	V/Hz	230/50 or 208 - 230 / 60	
Total power consumption	W	2000	2300

		FCW1200	FCW1200S
Working temperature range	°C	-20 ... 80	-15 ... 80
Cooling capacity (water-glycol)	°C	<u>20</u> <u>5</u> <u>-10</u>	<u>20</u> <u>5</u> <u>-10</u>
	W	1300 750 370	1200 650 260
Refrigerant		R134a	
Heater capacity	W	1200	
Pump capacity:			
Pressure max.	bar	0.5	1.2
Flow rate max.	l/min	20 / 14	22 / 15
with tubing connections	mm Ø	13,5/9,5	13,5/9,5
Pump connections		M16x1	M16x1
Noise level, 1 m distance	dBA	53	57
Filling volume	l	8 ... 11	
Dimensions (WxLxH)	mm	460 x 610 x 490	
Ambient temperature	°C	5 ... 40	
Shipping weight	kg	65	66
Mains power connection	V/Hz	230/50 or 208 - 230 / 60	
Total power consumption	W	2300	2800

All data have been determined at
ambient temperature: 20 °C

mains voltage: 230 V / 50 Hz
bath liquid: water-glycol

		FCW1600	FCW1600S
Working temperature range	°C	-20 ... 80	-15 ... 80
Cooling capacity	°C	<u>20</u> <u>5</u> <u>-10</u>	<u>20</u> <u>5</u> <u>-10</u>
(water-glycol)	W	1650 1000 470	1550 900 360
Refrigerant		R134a	
Heater capacity	W	1200	
Pump capacity:			
Pressure max.	bar	0.5	1.2
Flow rate max.	l/min	20 / 14	22 / 15
with tubing connections	mm Ø	13,5/9,5	13,5/9,5
Pump connections		M16x1	M16x1
Noise level, 1 m distance	dB(A)	53	57
Filling volume	l	8 ... 11	
Dimensions (WxLxH)	mm	460 x 610 x 490	
Ambient temperature	°C	5 ... 40	
Shipping weight	kg	65	66
Mains power connection	V/Hz	230/50 or	230 / 60
Total power consumption	W	2400	2900
All data have been determined at ambient temperature: 20 °C	mains voltage:	rated voltage and frequency	
	bath liquid:	water-glycol	

Temperature selection		digital (keypad)
Resolution	°C	0.1
MULTI-DISPLAY indications		LED + LED
Resolution	°C	0.1
Display accuracy	%	0.5
Temperature stability	°C	±0.2
Temperature control		on/off
Control ratio for feed/return flow temperature, adjustable	%	0 ... 100
Temperature sensor (number)		PTC (3)
Level indication		spy-glass
Error message indication		LED
Electrical connections:		
Computer interface		RS 232
Stand-by input		conforming to Namur recommendations
Alarm output		potential-free
Return flow safety device	V	230
External sensor (4-lead technique)		Pt100
Programmer	V/mA	0 to 10 / 0 to 24
Temperature recorder (0 V = 0 °C)	mV/K	10 (RI = 100 Ohms)

Technical specifications

Safety installations

(adjustable via LED):

High temperature protection	°C	-25 ... 85
Low temperature protection	°C	-25 ... 85
Low liquid level protection		float switch
Safety class		III
Overload protection for pump motor		contactor
Overload protection for cooling compressor		contactor
Alarm signal		optical + audible

Standards:

EMC regulations EN 61326

Guideline for first voltage range EN 61010-1, EN 61010-2-010

Pressure equipment directive EN 378

Environment:

Use only indoor.

Altitude up to 2000 m - normal zero.

Ambient temperature: +5 ... +40 °C (for storage and transportation)

Air humidity acc. DIN EN 61 010, part 1:

Max. rel. humidity 80 % for temperatures up to +31 °C,

linear decrease down to 50 % rel. humidity at a temperature of +40 °C

Protection class: IP 21 acc. EN 60 529

Power supply: acc. to class 1, VDE 0106 T1

not for use in explosive atmosphere

Max. mains fluctuation of ±10 % are permissible.

Pollution degree 2

Overvoltage category II

Only for water-cooled models FCW:

Cooling water pressure (IN / OUT)	max.	6 bar
Difference pressure (IN - OUT)		3.5 to 6 bar
Cooling water temperature		<20 °C

Quality of cooling water:

pH at 25 °C		7 to 8.5
Suspended matter		<30 mg/l
Size of suspended matter	max.	0.1 mm
Growth of algae		not permissible

15. EC Declaration of Conformity



The following unit complies with the essential safety requirements outlined by the EC Directives concerning the guidelines for electromagnetic compatibility (89/336/EEC), low voltage regulations (73/23/EEC) and the pressure equipment directive (97/23/EEC).

Recirculating coolers:

FC600	FC600S	FCW600	FCW600S
FC1200	FC1200S	FCW1200	FCW1200S
FC1600	FC1600S	FCW1600	FCW1600S

This unit is manufactured in compliance with the following guidelines

electrical equipment for control technology and laboratory application –
EMC requirements outlined by
EN 61326

safety regulation for electrical devices for measuring, control and
laboratory application specified by
EN 61010

refrigerated and heating circulators – safety and environmental – conscious
requirements outlined by
EN 378

Julabo
Julabo Labortechnik GmbH
Eisenbahnstr. 45
D-77960 Seelbach / Germany

G. Juchheim, Managing Director

16. Warranty conditions

JULABO Labortechnik GmbH warrants its products against defects in material or in workmanship, when used under appropriate conditions and in accordance with appropriate operating instructions

for a period of ONE YEAR.

Extension of the warranty period – free of charge



With the '1PLUS warranty' the user receives a free of charge extension to the warranty of up to 24 months, limited to a maximum of 10 000 working hours.

To apply for this extended warranty the user must register the unit on the JULABO web site www.julabo.de, indicating the serial no. The extended warranty will apply from the date of JULABO Labortechnik GmbH's original invoice.

JULABO Labortechnik GmbH reserves the right to decide the validity of any warranty claim. In case of faults arising either due to faulty materials or workmanship, parts will be repaired or replaced free of charge, or a new replacement unit will be supplied.

Any other compensation claims are excluded from this guarantee.