



# Operating Manual



**WHISPER**



**M-Series**



**MB-Series**



**MS-Series**

## Precision Gas Mass Flow Meters

*The Fastest Flow Controller Company in the World!*



**Thank you for purchasing an Alicat flow meter.**

We know you are going to love your new flow meter. If you have any questions about operating it, or if something is not working as expected, please let us know. We are eager to help you in any way possible.

**Alicat Scientific, Inc.**

info@alicat.com • alicat.com

7641 N Business Park Drive, Tucson, AZ 85743 USA

1-888-290-6060

Serial Number: \_\_\_\_\_

Next Calibration: \_\_\_\_\_

**Recalibrate your flow meter every year.**

Your calibration date is labeled on the back of the flow meter. Write that date in the space above. When it's time for your flow meter's annual recalibration, contact us by phone, email or live chat to set it up, or fill out the Service Request Form at [alicat.com/service](http://alicat.com/service).



This Alicat device comes with a NIST traceable calibration certificate.



This Alicat flow meter conforms to the European Union's Restriction of Use of Hazardous Substances in Electrical and Electronic Equipment (RoHS) Directive 2011/65/EU.



This Alicat flow meter complies with the requirements of the Low Voltage Directive 2014/35/EU and the EMC Directive 2014/30/EU and carries the CE Marking accordingly.



This Alicat flow meter complies with the requirements of the European Union's Waste Electrical & Electronic Equipment (WEEE) Directive 2002/96/EC.

## Welcome to the Alicat way.

You're busy, and the last thing you want to do is waste time wrestling with your flow meter. We're here to make your life a little easier so you can do what you do best. It's our pleasure to introduce you to your new Alicat:

- **High-accuracy performance for all your gases.** Use your flow meter with any of the 98 or more gases that are part of Gas Select™, *page 23*.
- **1000 readings per second** ensures high resolution of data, *page 29*.
- **Monitor pressure and temperature during flow measurement.** View internal stream absolute pressure and temperature, *page 17*.
- **Backlit display with adjustable contrast** is easy to read in direct sunlight. In dimly lit areas, press the Alicat logo to turn on the backlight, *page 7*.
- **Change your STP** to match any standard temperature and pressure reference, *page 27*.
- **Log data to your PC.** Talk to the flow meter serially to capture all flow data for logging and analysis, *page 31*.

This manual covers the following Alicat Scientific instruments:

- **M-Series Mass Flow Meters**
- **MQ-Series High-Pressure Mass Flow Meters**
- **MS-Series Mass Flow Meters for use with Aggressive Gases**
- **MW (WHISPER) Low Pressure Drop Mass Flow Meters**
- **MB-Series Portable Mass Flow Meters**
- **MBS-Series Portable Mass Flow Meters for Aggressive Gases**
- **MQB-Series Portable High-Pressure Mass Flow Meters**
- **MWB (WHISPER) Portable Low Pressure Drop Mass Flow Meters**

This includes M-Series devices labeled as approved for CSA Class 1 Div 2 and ATEX Class 1 Zone 2 hazardous environments. See page 87 for Special Conditions regarding the use of CSA/ATEX labeled devices.



*Please contact Alicat at 1-888-290-6060 or [info@alicat.com](mailto:info@alicat.com) if you have any questions regarding the use or operation of this device.*

# Table of Contents

<b>Quick-Start Guide</b>	<b>6</b>
<b>Getting Started</b>	<b>7</b>
Getting to Know Your Alicat .....	7
<i>Connectors and Buttons</i> .....	7
<i>The Flow Meter Display</i> .....	8
<i>Status Messages</i> .....	8
Option: Charging Your Portable Flow Meter .....	9
Mounting .....	10
Plumbing .....	10
Filters .....	10
Connecting Your Gas Flow Meter .....	11
Power and Signal Connections .....	12
<i>RS-232 / RS-485 Digital Input / Output Signal</i> .....	13
<i>Analog Signals</i> .....	14
Option: Color TFT Display .....	15
<b>Navigating and Customizing Your Flow Meter</b>	<b>16</b>
Flow Meter Menu Map .....	16
Collecting Live Flow Data .....	17
Choosing Engineering Units .....	18
Option: Collecting Totalized Flow Data .....	19
Menu .....	20
<i>Taring Your Flow Meter</i> .....	20
About .....	21
<i>Diagnostic Information</i> .....	21
Basic Configuration Menu .....	22
<i>Choosing Device Engineering Units from the Basic Configuration Menu</i> .....	22
Gas Select™ .....	23
<i>Gas Select™ Gas List</i> .....	24
<i>Using COMPOSER™ to Personalize Mixed Gas Compositions</i> .....	25
<i>Adding a new mixed gas composition to COMPOSER</i> .....	26
Defining STP/NTP Reference Values .....	27
Advanced Setup .....	28
Display Setup .....	28
Sensor Setup .....	29
Configuring Your Flow Meter for Serial Communications .....	30

<b>Serial Communications</b>	<b>31</b>
Establishing Serial Communications .....	31
Serial Streaming vs Polling .....	32
Taring Serially .....	33
Collecting Flow Data Serially.....	33
Quick Serial Command Guide .....	34
Using Gas Select and COMPOSER Serially .....	35
<b>Troubleshooting Your Flow Meter</b>	<b>36</b>
<b>Maintenance and Recalibration</b>	<b>39</b>
<b>Gas Properties Data</b>	<b>40</b>
<b>Numerical List of Gases</b>	<b>48</b>
<b>Device Units</b>	<b>51</b>
<b>Accessories</b>	<b>53</b>
<b>Specification Sheets</b>	<b>55</b>
<b>Optional Pinouts</b>	<b>83</b>
<b>Additional Information for Alicat CSA and ATEX Approved Devices</b>	<b>87</b>
<b>Limited Lifetime Warranty</b>	<b>89</b>

# Quick-Start Guide

## Setup

- **Tare your flow meter.** Before you connect the flow meter, ensure that no air is flowing through the device and select **TARE FLOW** from Main Display.



*Note: Whisper flow meters are sensitive enough to measure the lightest of breezes, so ensure that one end is plugged before selecting tare.*

- **Choose your engineering units.** Press the button above or below any parameter to enlarge it in the middle of the display. If you select that same item a second time, you can change the engineering unit for that parameter. You can choose units for all of the parameters at once by selecting **MENU > BASIC CONFIG > DEVICE UNITS**.

- **Connect your flow meter.** Ensure that flow through your device will be in the same direction as the arrow on the flow body (usually left to right).

## Operation: Flow Verification

- **Monitor live flow readings.** You can monitor live readings of flow, pressure and temperature by viewing the screen. Readings are updated in real time.
- **Tare your flow meter before you begin another round of measurements.** Ensure that no flow is passing through your meter, and select **TARE FLOW**.
- **(Optional) Capture a totalized reading.** The totalizer option displays the total flow that has passed through the device since the last time the totalizer was reset. Press **TOTAL/MENU** to access the totalizer.

## Maintenance and Care

- If your gas is clean, your flow meter will require no periodic cleaning.
- **Calibrate your flow meter annually.** Request an Alicat factory calibration at [alicat.com/service](http://alicat.com/service) or by calling Alicat at 1-888-290-6060.

# Getting Started

## Getting to Know Your Alicat

### Connectors and Buttons

The drawings below represent typical configurations of a standard Alicat mass flow meter (M series) and a standard battery-powered mass flow meter (MB series). Your flow meter's appearance and connections may differ.

#### MB-Series Portable Mass Flow Meter

#### M-Series Mass Flow Meter

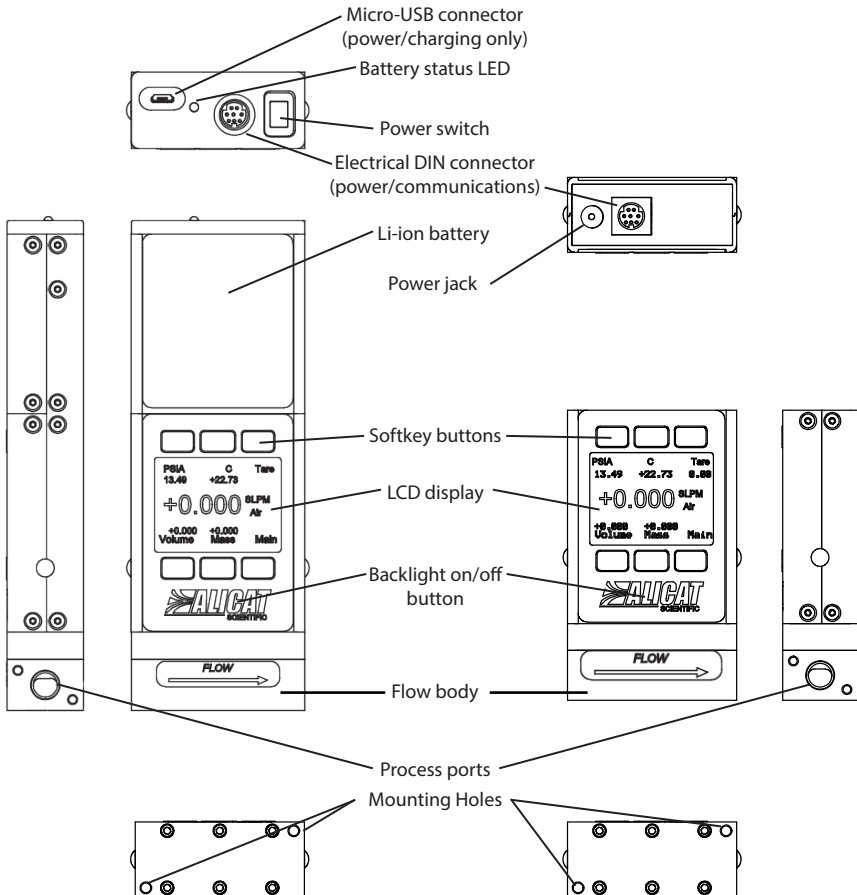

# Getting Started

## The Flow Meter Display

The figure below identifies the various features of the flow meter display. Press the large button with the Alicat logo to toggle the backlight on and off. For more details, see the Menu Map on page 16 and the menu-by-menu descriptions that follow it.

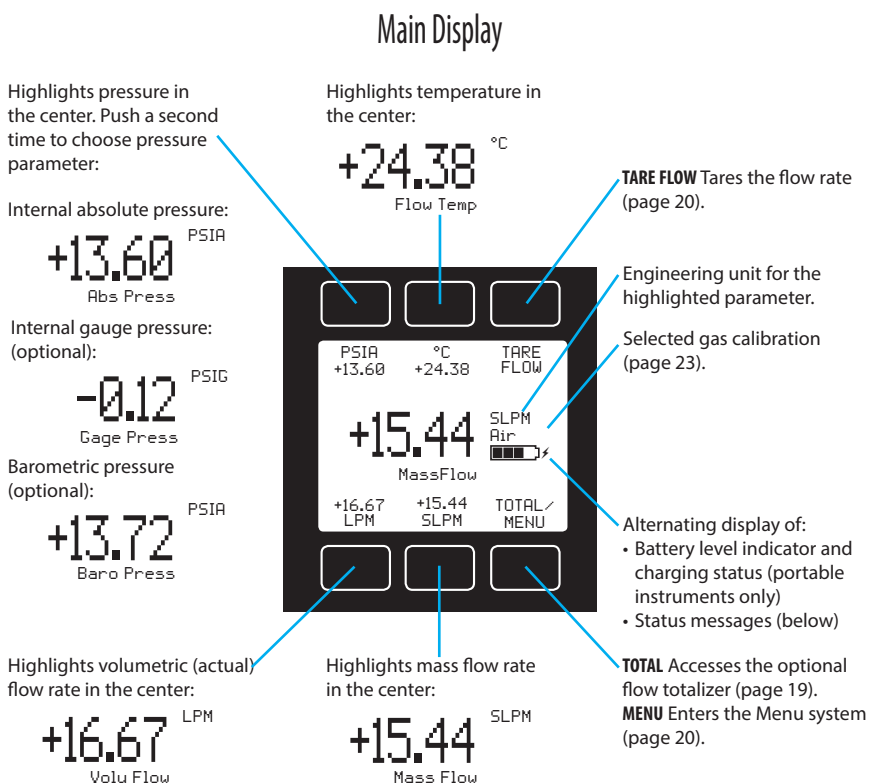

## Status Messages

Analog-digital converter error:	<b>ADC</b>
Front display is locked:	<b>LCK</b>
Mass flow over range of device:	<b>MOV</b>
Totalizer rolled over to 0:	<b>OVR</b>
Pressure over range of device:	<b>POV</b>
Totalizer missed out of range flow:	<b>TMF</b>
Temperature over range of device:	<b>TOV</b>
Volumetric flow over range of device:	<b>VOV</b>



# Getting Started

## Option: Charging Your Portable Flow Meter

If you purchased a portable meter, we've fully charged it at the factory, so you can use it right away. Typical battery life of a fully-charged battery is 18 hours with a monochrome display or 5 hours with a TFT color display, when the backlight is set to 10. Dimming the backlight will increase battery life.

The battery indicator on the right side of the Main Display reflects the relative battery level. When the battery indicator is completely empty, approximately 15 minutes of battery life remains. Please charge the flow meter as soon as possible to maintain full device performance.

Charge the flow meter using the supplied USB cable (micro-B to type A) or any similar cable. You may charge the flow meter using any USB outlet on a computer or portable power supply, but charging will be fastest (approximately 3.5 hours) when connected to the supplied 2.0A power supply.

The green/red indicator LED on top of the device lights up green to indicate that the unit is charging. The green LED turns off when the battery is charged.

The LED flashes red when the device has approximately 1 hour of battery life remaining. The LED flashes red at a faster rate when the device has approximately 15 minutes of battery life remaining.

Your flow meter may be used while it is charging. A small lightning bolt symbol (⚡) will appear to the right of the battery symbol while the device is charging. If the battery has been fully depleted, you may need to charge the flow meter for a full minute before the device can be turned on.

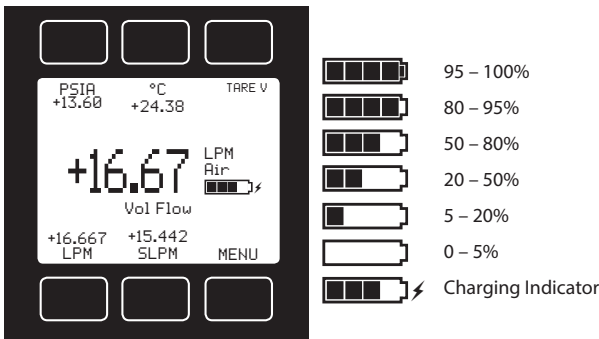

**Warning:** If the device is left on until the battery can no longer power it, the charge indicator will fall out of sync with the actual charge. The device can be re-synced by fully charging the battery once.

**Warning:** The safe charging temperature range is 0-45 °C (32-113 °F). If internal sensors detect temperatures outside of this range, the battery will not charge.

# Getting Started

## Mounting

No straight runs of pipe are required upstream or downstream of the meter. For most Alicat flow meters, you can mount or hold the meter in any position, because it is internally compensated for any changes to its orientation during use. (MS/MBS series flow meters use media-isolated sensors that must be tared after changing orientation.) Your flow meter is also minimally affected by vibrations, so you can rest it on top of a vibrating instrument with little impact to measurement accuracy.

## Plumbing

Your flow meter has been shipped with plastic plugs fitted into its ports. To lessen the chance of contaminating the flow stream, do not remove these plugs until you are ready to install the device.

Standard Alicat Gas Flow Meters have female inlet and outlet ports. Welded VCR and other specialty fittings may have male connections.

- » If you are using a fitting that does not have a face seal, use thread-sealing Teflon tape to prevent leakage around the port threads, but do not wrap the first two threads. This will minimize the possibility of getting tape into the flow stream and clogging the laminar flow elements (LFE).
- » If you are using a fitting that has a face seal, there is no need to apply Teflon tape to the threads.



***Warning: Do not use pipe dopes or sealants on the process connections, as these compounds can cause permanent damage to the meter should they get into the flow stream.***

## Filters

When pressure drop is not an issue, use in-line sintered filters to prevent large particulates from entering the flow meter. Suggested maximum particulate sizes are as follows:

- » 5 microns for units with flow ranges of 1 sccm or less.
- » 20 microns for units with flow ranges between 2 sccm and 1 slpm.
- » 50 microns for units with flow ranges of 1 slpm or more.

# Getting Started

## Connecting Your Gas Flow Meter

Your Alicat flow meter can measure flow generated by positive pressure and/or suction. Connect the meter so that the flow travels in the same direction as the flow arrow, usually from left to right as you look at the front of the device.

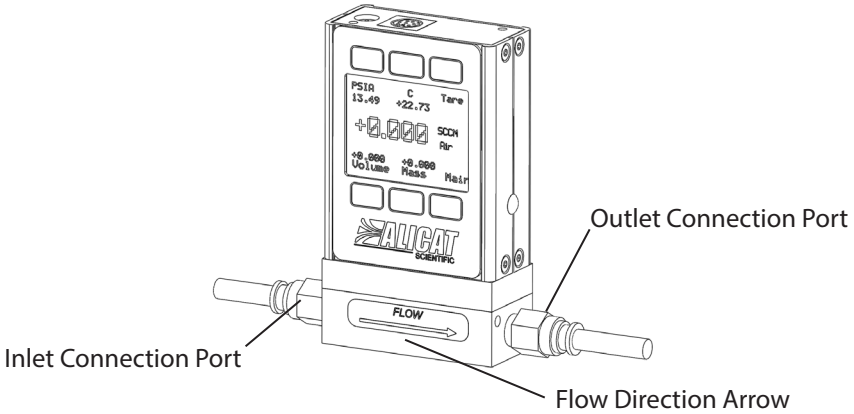

**Warning:** Using the flow meter above the maximum specified internal line pressure, or above the maximum recommended differential pressure between the inlet and outlet, will result in permanent damage to the internal pressure sensors.

A common cause of this problem is the instantaneous application of high-pressure gas, as from a snap-acting solenoid valve either upstream or downstream of the meter. If you suspect that your pressure sensor is damaged, please discontinue use of the meter and contact Alicat.

See the chart below for pressure limits.

Model	Max Line Pressure	Max Differential Pressure
M/MS/MB/MBS	145 psig	75 psid
MW/MWB	45 psig	15 psid
MQ/MQB	305 psig	100 psid

# Getting Started

## Power and Signal Connections

Power can be supplied to your meter through either the power jack or the multi-pin connector on top of your device.

- ✓ **Meter power jacks require a 7-30 Vdc power supply with a 2.1 mm female positive center plug capable of supplying at least 100 mA. 4-20 mA analog signal outputs require at least 15 Vdc and 120 mA, and 0-10 Vdc outputs require at least 10 Vdc.**

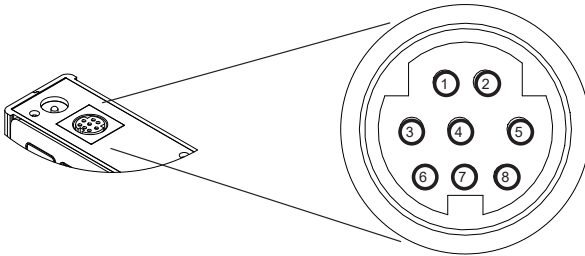

### Standard 8-Pin Mini-DIN Pinout

Pin	Function	Mini-DIN cable color
1	Not Connected (or optional 4-20 mA Primary Output Signal)	Black
2	Static 5.12 Vdc (or optional Secondary Analog Output [4-20 mA, 0-5 Vdc, 1-5 Vdc, 0-10 Vdc] or Basic Alarm)	Brown
3	Serial RS-232RX / RS-485(-) Input Signal (receive)	Red
4	Remote Tare (ground to tare)	Orange
5	Serial RS-232TX / RS-485(+) Output Signal (send)	Yellow
6	0-5 Vdc (or optional 1-5 Vdc or 0-10 Vdc) Output Signal	Green
7	Power In (as described above)	Blue
8	Ground (common for power, digital communications, analog signals and alarms)	Purple

Note: The above pinout is applicable to all the flow meters and controllers with the Mini-DIN connector. The availability of different output signals depends on the options ordered. Optional configurations are noted on the unit's calibration sheet.



**Caution: Do not connect power to pins 1 through 6, as permanent damage can occur.**

*It is common to mistake Pin 2 (labeled 5.12 Vdc Output) as the standard 0-5 Vdc analog output signal. Pin 2 is normally a constant 5.12 Vdc that reflects the system bus voltage.*

*For 6-pin locking industrial connector, DB9, and DB15 pinouts, see page 83 to page 86 or visit [alicat.com/pinout](http://alicat.com/pinout).*

# Getting Started

## RS-232 / RS-485 Digital Input / Output Signal

To use the RS-232 or RS-485 digital signal, connect the RS-232 / RS-485 Output Signal (Pin 5), the RS-232 / RS-485 Input Signal (Pin 3) and Ground (Pin 8) to your serial port as shown below. (See "Serial Communications" on page 39 for details)

### DB9 to 8-Pin Mini-DIN Connection for RS-232 / RS-485 Signals

9 Pin Serial Connection		8 Pin Mini-DIN Connection	
Pin	Function	Function	Pin
5	Ground	Ground	8
3	Transmit	Receive	3
2	Receive	Transmit	5

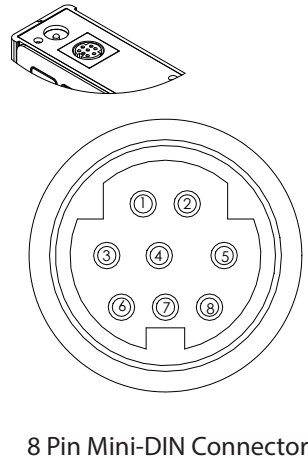
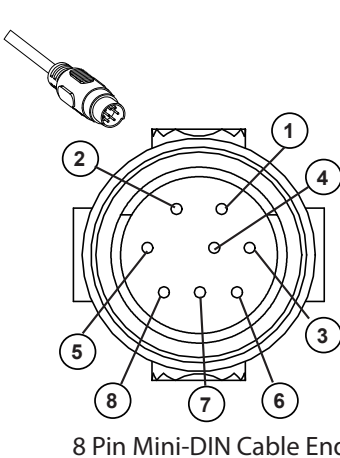
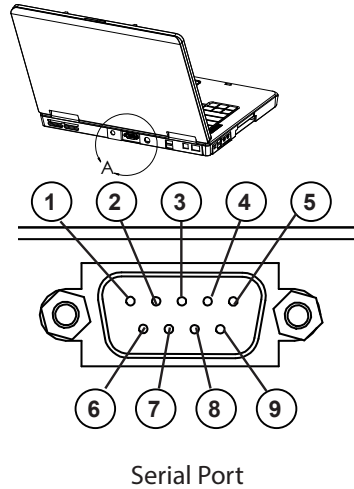
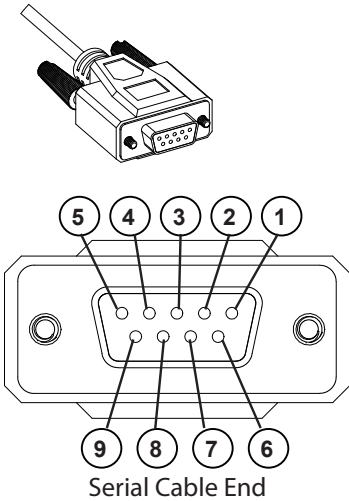

# Getting Started

## Analog Signals

### Primary Analog Output Signal

Most Alicat instruments include a primary analog output signal, which is linear over its entire range. For both standard 0-5 Vdc and optional 0-10 Vdc output signals, a zero flow condition is usually in the range of 0.010 Vdc. Zero flow for the optional 1-5 Vdc and 4-20 mA output signals is 1 Vdc and 4 mA, respectively. Full-scale flow is 5 Vdc for 0-5 Vdc and 1-5 Vdc signals, 10 Vdc for 0-10 Vdc signals and 20 mA for 4-20 mA signals.

Alicat's default 8-pin mini-DIN connector places the primary analog output on Pin 6 for voltage signals and Pin 1 for 4-20 mA current signals. Ground for these signals is common on Pin 8.

### Option: Second Analog Output Signal

Alicat's default 8-pin mini-DIN connector places the secondary analog output on Pin 2 for both voltage and current signals. Your device's secondary analog signal may differ from its primary output signal.



**See the Calibration Sheet that shipped with your meter to determine which output signals were ordered.**

### Option: 4-20 mA Current Output Signal

If your meter has a 4-20 mA current primary or secondary output signal, your flow meter will require 15-30 Vdc power.



**Caution: Do not connect 4-20 mA devices to "loop powered" systems, as this will destroy portions of the circuitry and void the warranty. If you must interface with existing loop powered systems, always use a signal isolator and a separate power supply.**

### Analog Remote Tare

You can tare your mass flow meter remotely by momentarily grounding Pin 4 as shown below.

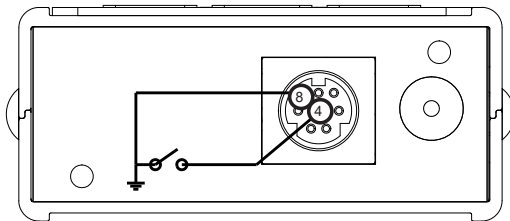

# Getting Started

## Option: Color TFT Display

Instruments ordered with a color display function the same as standard backlit monochrome instruments, but color is used to provide additional on-screen information.

### Multi-Color Display Indicators

- » **GREEN:** Parameter labels and adjustments associated with the button directly above or below the label are presented in green.
- » **WHITE:** The color of each parameter is displayed in white while operating under normal conditions.
- » **RED:** The color of a parameter is displayed in red when its value exceeds 128% of the device's specifications.
- » **YELLOW:** Menu items that are ready to be selected appear in yellow. This color replaces the symbol (>) in selections on monochrome display.

 ***Press the Alicat logo button to turn off the color display backlight. The flow meter remains in operation while the backlight is off.***

### LCD Contrast

LCD contrast is ranged from 0 to 11 on color displays, with 11 indicating the greatest contrast. See "Display Setup" on page 28.

### Specifications for Instruments with Color Displays

The following specifications replace the standard power specifications when the instrument is equipped with a color display. All other specifications from your device's specification sheet remain in effect.

Specification	Meter
Supply Voltage	7 to 30 Vdc
Supply Current	80 mA @ 12Vdc 70 mA @ 24Vdc

# Navigating and Customizing Your Flow Meter

## Flow Meter Menu Map

### Start Here

- \* Main Display

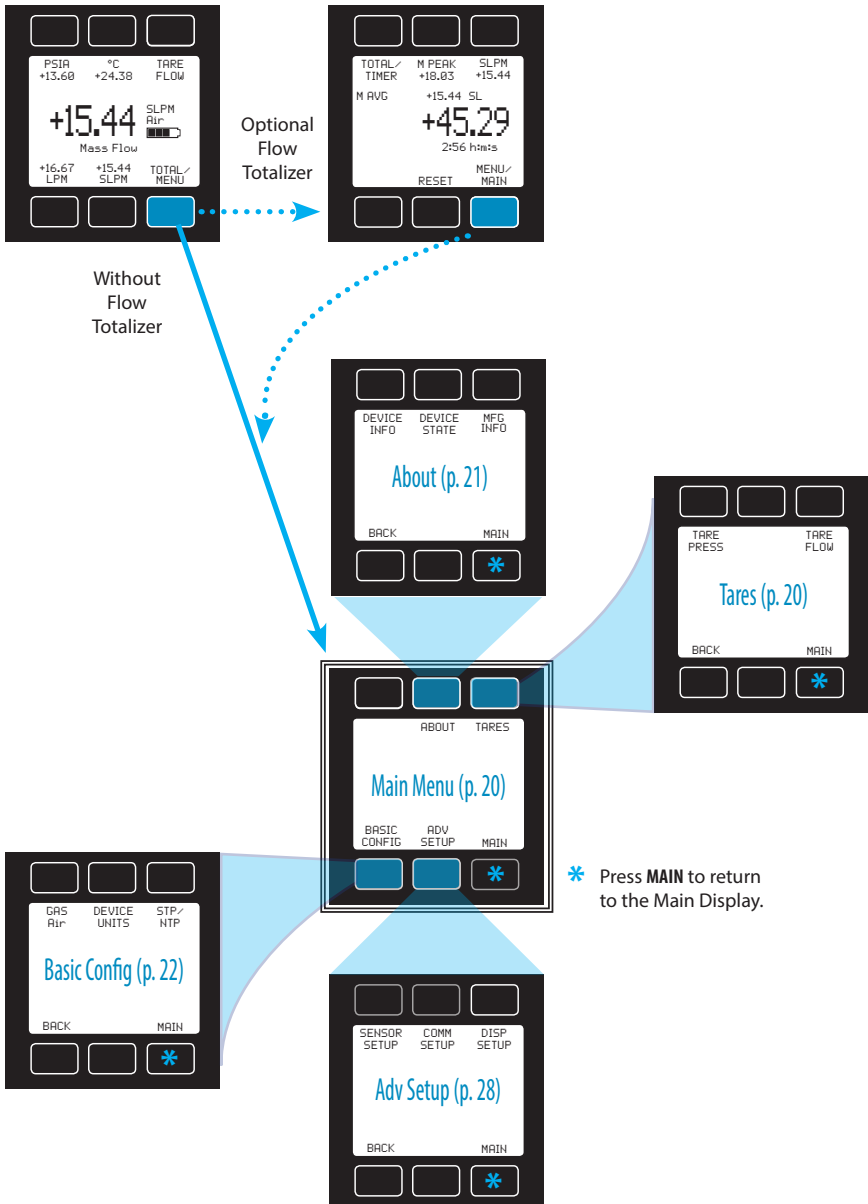



# Navigating and Customizing Your Flow Meter

## Collecting Live Flow Data

The Main Display has two primary functions:

- Collecting live temperature, pressure and flow data (see below)
- Changing engineering units for temperature, pressure and flow (page 18)

This screen displays live data for all flow parameters simultaneously. Live data is measured 1000 times every second but refreshed more slowly on the display. Press the button above or below any of the four flow parameters once to highlight its value in the center of the screen. Press the same button again to enter the engineering unit selection menu for that parameter (page 18).

## Main Display

Highlights pressure in the center. Push a second time to choose pressure parameter:

Internal absolute pressure:  
**+13.60** PSIA  
Abs Press

Internal gauge pressure:  
(not available on all devices):  
**-0.12** PSIG  
Gage Press

Barometric pressure  
(not available on all devices):  
**+13.72** PSIA  
Baro Press

Highlights volumetric (actual) flow rate in the center:  
**+16.67** LPM  
Volu Flow

Highlights temperature in the center:  
**+24.38** °C  
Flow Temp

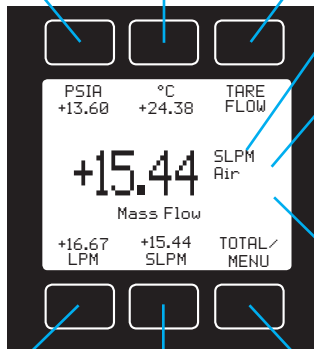

**TARE FLOW** Tares the flow rate (page 20).

Engineering unit for the highlighted parameter.

Selected gas calibration (page 23).

Alternating display of:  
• Status messages (page 8)  
• Portable instruments show battery level indicator and charging status (page 9)

**TOTAL** Accesses the optional flow totalizer (page 19).  
**MENU** Enters the Menu system (page 20).

# Navigating and Customizing Your Flow Meter

## Choosing Engineering Units

Press the button above or below any of the four flow parameters twice to enter its unit selection menu. You can change units in two ways:

**Button engineering units** alter the display only, not the serial data frame:

- Select **Set button eng units** and press **SELECT** to change the engineering unit on the display only. This does not alter the flow meter data frame.

**Device engineering units** alter both the display and the flow meter data frame:

- Select **Set device eng units** and then choose the engineering unit as above. An additional confirmation screen asks you to confirm the serial change.
- If the button engineering unit is different than the device engineering unit, **Set device eng units** will not appear. First select **Show device eng units** to revert the button to the current device unit for that parameter. Enter the unit selection menu again to change the device engineering unit.

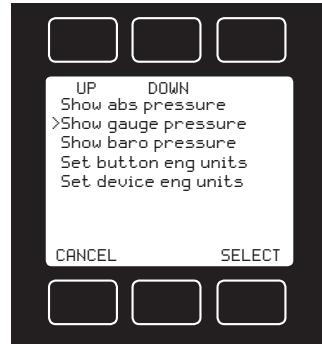

The example above shows the unit selection menu for a device that has the internal barometer option.

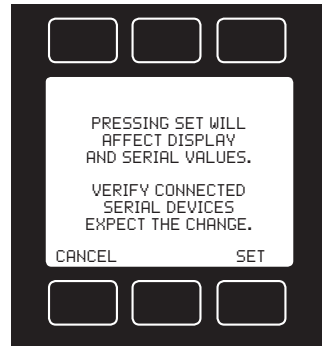

Examples of changing device engineering units:

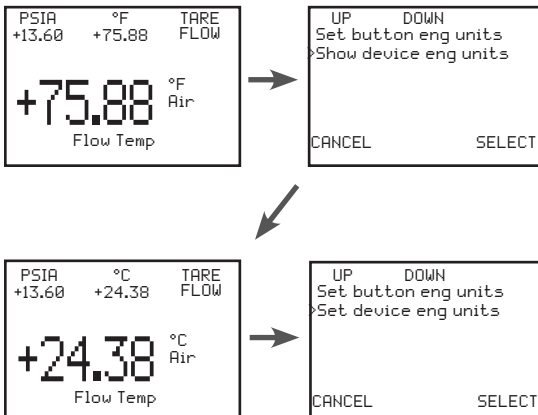

### Changing device units:

°F is not the existing device engineering unit, so the unit selection menu displays **Show device eng units**. Select this to revert the button unit to the device unit for this parameter.

### Changing device units:

°C is the existing device engineering unit, so the unit selection menu displays **Set device eng units**. Select this to choose a new unit.

# Navigating and Customizing Your Flow Meter

## Option: Collecting Totalized Flow Data

Your flow meter may have been purchased with an optional flow totalizer. This displays the total amount of mass or volume that has flowed through the instrument since its last reset, like a gasoline pump. You can access the totalizer screen by pressing **TOTAL/MENU** on the Main Display.

### Totalizer (Optional)

**TOTAL/TIMER** Toggles between totalized flow and elapsed time as the parameter highlighted in the center.

**M PEAK** or **V PEAK** Displays the maximum flow rate since last reset. Press to select engineering units.

Displays live flow rate. Press to select engineering units.

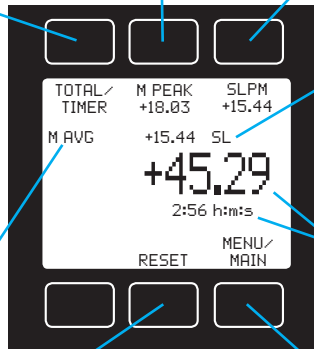
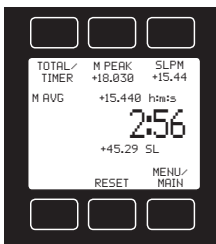

Alternating display of:

- Selected engineering unit for totalized flow or time (page 22).
- Selected gas calibration (page 23).

Displays totalized flow and elapsed time since last reset. Time units alternate with status messages when any are present (page 8).

Optional totalizer averaging: Displays average flow rate since last reset, updated live.

**RESET** Clears all totalized data and resets the timer to 0. Totalization of flow data continues immediately.

**MENU/MAIN** Enters the Menu system (page 20). From there, press **MAIN** to exit to the Main Display of live data.

### Totalizer Rollover Functions

Your flow totalizer has been configured to report a maximum of 7 digits. By default, the placement of the decimal is the same as the live flow rate. The totalizer can be configured at the time of order for the following behaviors. (By default, the totalizer rolls over and displays OVR.)

- **Rollover:** Totalizer resumes counting from 0 as soon as the maximum count has been reached.
- **Freeze:** Totalizer stops counting at max count, until it is reset manually.
- **Error:** Displays OVR status message when maximum count has been reached; compatible with Rollover and Freeze.

The elapsed time counter has a maximum value of 9999:59:59 (h:m:s). If flow is still being totalized at that point, the timer freezes, regardless of the behavior chosen above for the totalized flow readings.

# Navigating and Customizing Your Flow Meter

## Menu

You can enter the menu system by pressing the **MENU** button from the Main Display.

**Menu**

**ABOUT** Enters the About Menu (page 21).

**TARES** Enters the Tares Menu (below).

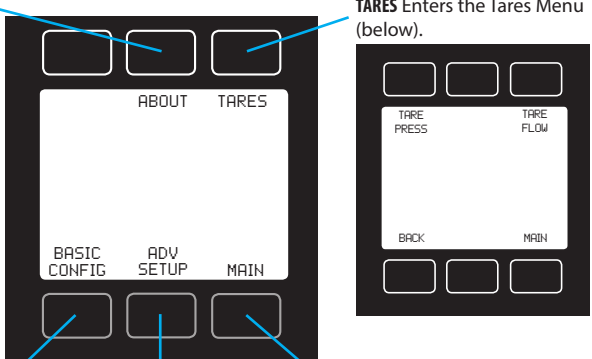

**BASIC CONFIG** Enters the Basic Configuration Menu (page 22).

**ADV SETUP** Enters the Advanced Setup Menu (page 28).

**MAIN** Exits to the Main Display (page 17).

## Taring Your Flow Meter

Taring is an important practice that ensures that your flow meter is providing the most accurate measurements possible. This function gives the flow meter a good zero reference for flow measurements. For meters with a barometer, taring can also be used to align the internal absolute pressure sensor with the barometric pressure reading.

### How to Tare

1. Ensure that nothing is flowing through the device.
2. **MENU > TARE > TARE FLOW**. Flow tares should occur at the expected process pressure, as long as there is no flow.
3. **MENU > TARE > TARE PRESS** Absolute pressure tares must be done with the controller open to atmosphere.

### When to Tare

- Before every new flow measurement cycle.
- After significant changes in temperature or pressure.
- After dropping or bumping the flow meter.
- After installing the meter in a different orientation.

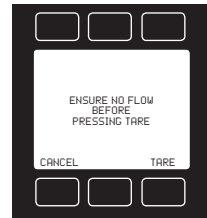

**TARE FLOW**

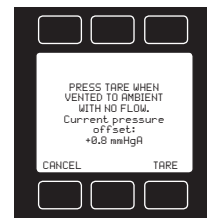

**TARE PRESS**

# Navigating and Customizing Your Flow Meter

## About

We hope you don't run into trouble using your flow meter, but if you do, the **ABOUT** menu contains information that can make the troubleshooting process easier. Select **MFG INFO** to look up Alicat's phone number and web address. **DEVICE INFO** shows you the serial number and firmware version (**SW:**) for your specific device. It also gives you the original manufacturing date and the last calibration date, as well as the initials of the Alicat calibrator.

### Menu | About

**DEVICE STATE** Displays diagnostic information for troubleshooting (below).

**DEVICE INFO** Displays serial number, firmware revision and calibration information.

**MFG INFO** Displays Alicat's contact information.

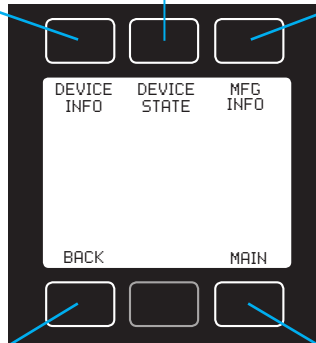
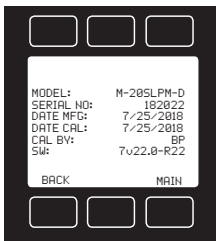

**BACK** Returns to the top-level Menu (page 20).

**MAIN** Exits to the Main Display (page 17).

## Diagnostic Information

The **DEVICE STATE** screen displays live values for the internal device registers. Many of these values can help an Alicat applications engineer diagnose operational issues over the phone. Some register values clearly distinguish between hardware and operational problems, which speeds up the troubleshooting process.

Within the **DEVICE STATE** screen, press **PAGE** to advance to the next page of register values.

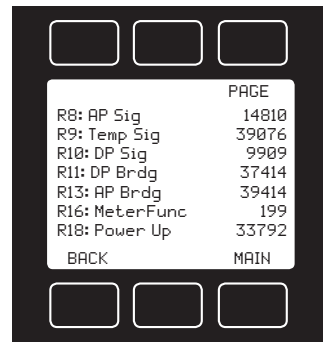

# Navigating and Customizing Your Flow Meter

## Basic Configuration Menu

The Basic Configuration Menu contains options for choosing the gas calibration, device engineering units and STP/NTP mass flow references.

### Menu | Basic Configuration

**GAS** Enters Gas Select and COMPOSER menus (page 23).

**DEVICE UNITS** Changes device engineering units for any parameter:  
Mass Flow - Volumetric Flow -  
Pressure - Temperature -  
(Volu Totalizer - Mass Totalizer - Totalizer Time)

**STP/NTP** Defines standard (STP) and normal (NTP) temperature and pressure conditions (page 27).

**BACK** Returns to the top-level Menu (page 20).

**MAIN** Exits to the Main Display (page 17).

The diagram shows a central menu screen with three buttons at the top labeled GAS, DEVICE UNITS, and STP/NTP. Below these are two buttons labeled BACK and MAIN. Blue arrows point from the text callouts to each of these five buttons.

## Choosing Device Engineering Units from the Basic Configuration Menu

Changing device engineering units alters both the display and the data frame. First choose the parameter whose unit you want to change, and then select your desired engineering unit, confirming the change on the last screen. If your meter has been configured with a flow totalizer, this screen will also include units for totalized volumetric and mass flow, plus elapsed time.

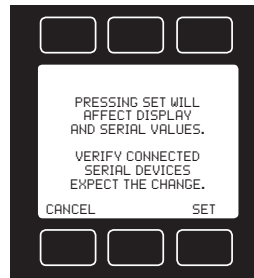
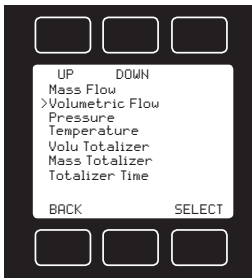

# Navigating and Customizing Your Flow Meter

## Gas Select™

In most cases, your flow meter was physically calibrated on air at Alicat's factory. Gas Select™ allows you to reconfigure the flow meter to flow a different gas without sending it back to Alicat for a physical recalibration.

To use Gas Select, simply choose a gas or gas mix from one of the listed categories. As soon as you press **SELECT** from the gas listing, your flow meter will reconfigure itself to flow your chosen gas. There is no need to restart the flow meter.

Your current gas selection appears just below the unit's indicator on the right side of the Main Display:

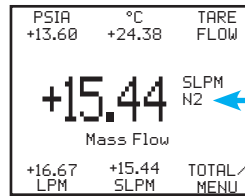

Gas Select set to nitrogen (N2).

## Gas Select - Category Listing

**UP/DOWN** Moves the selection arrow up or down the listing of gas categories.

**PAGE** Advances the view to the next page of categories.

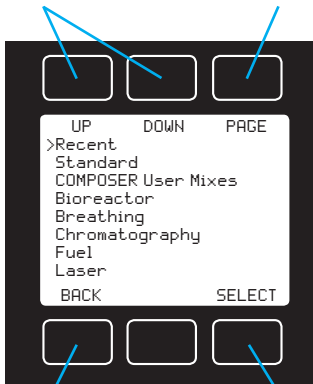

**BACK** Returns to the Basic Configuration Menu (page 22).

**SELECT** Opens the category to view its gases.

## Gas Select - Gas Listing

**UP/DOWN** Moves the selection arrow up or down the listing of gases.

**PAGE** Advances the view to the next page of gases.

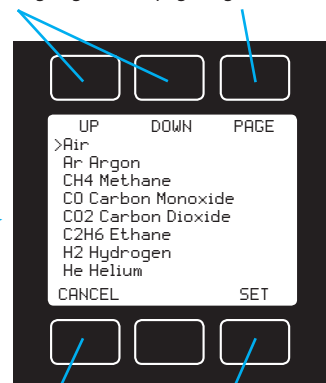

**CANCEL** Returns to the listing of gas categories.

**SET** Loads the gas properties data for the selected gas and exits to the Main Display (page 17).

# Navigating and Customizing Your Flow Meter

## Gas Select™ Gas List

Your Alicat is preloaded with gas properties data for the following gases. See page 40 for gas properties data (viscosity, density and compressibility).

### Pure Non-Corrosive Gases

- **Acetylene** C<sub>2</sub>H<sub>2</sub>
- **Air**
- **Argon** Ar
- **iso-Butane** iC<sub>4</sub>H<sub>10</sub>
- **normal-Butane** nC<sub>4</sub>H<sub>10</sub>
- **Carbon dioxide** CO<sub>2</sub>
- **Carbon monoxide** CO
- **Deuterium** D<sub>2</sub>
- **Ethane** C<sub>2</sub>H<sub>6</sub>
- **Ethylene** (Ethene) C<sub>2</sub>H<sub>4</sub>
- **Helium** He
- **Hydrogen** H<sub>2</sub>
- **Krypton** Kr
- **Methane** CH<sub>4</sub>
- **Neon** Ne
- **Nitrogen** N<sub>2</sub>
- **Nitrous Oxide** N<sub>2</sub>O
- **Oxygen** O<sub>2</sub>
- **Propane** C<sub>3</sub>H<sub>8</sub>
- **Sulfur Hexafluoride** SF<sub>6</sub>
- **Xenon** Xe

### Pure Corrosive Gases (\*S-series only)

- **Ammonia** NH<sub>3</sub>
- **Butylene** 1Buten
- **Cis-Butene** cButen
- **iso-Butane** iButen
- **Trans-Butene** tButen
- **Carbonyl Sulfide** COS
- **Chlorine** Cl<sub>2</sub>
- **Dimethylether** DME
- **Hydrogen Sulfide** H<sub>2</sub>S
- **Nitrogen Trifluoride** NF<sub>3</sub>
- **Nitric Oxide** NO
- **Propylene** C<sub>3</sub>H<sub>6</sub>
- **Silane** SiH<sub>4</sub>
- **Sulfur Dioxide** SO<sub>2</sub>

### Breathing Gas Mixes

- Metabolic Exhalant
- EAN-32
- EAN-36
- EAN-40
- EA-40
- EA-60
- EA-80
- Heliox-20
- Heliox-21
- Heliox-30
- Heliox-40
- Heliox-50
- Heliox-60
- Heliox-80
- Heliox-99

### Bioreactor Gas Mixes

- 5% CH<sub>4</sub>
- 10% CH<sub>4</sub>
- 15% CH<sub>4</sub>
- 20% CH<sub>4</sub>
- 25% CH<sub>4</sub>
- 30% CH<sub>4</sub>
- 35% CH<sub>4</sub>
- 40% CH<sub>4</sub>
- 45% CH<sub>4</sub>
- 50% CH<sub>4</sub>
- 55% CH<sub>4</sub>
- 60% CH<sub>4</sub>
- 65% CH<sub>4</sub>
- 70% CH<sub>4</sub>
- 75% CH<sub>4</sub>
- 80% CH<sub>4</sub>
- 85% CH<sub>4</sub>
- 90% CH<sub>4</sub>
- 95% CH<sub>4</sub>

### Refrigerants (\*S-series only)

- R-11
- R-115
- R-116
- R-124
- R125
- R-134A
- R-14
- R-142b
- R-143a
- R-152a
- R-22
- R-23
- R-32
- RC-318
- RC-404A
- RC-407C
- R-410A
- R-507A

### Welding Gas Mixes

- C-2
- C-8
- C-10
- C-15
- C-20
- C-25
- C-50
- C-75
- He-25
- He-50
- He-75
- He-90
- A1025
- Stargon CS

### Stack/Flue Gas Mixes

- 2.5% O<sub>2</sub>+10.8% CO<sub>2</sub>+85.7% N<sub>2</sub>+1% Ar
- 2.9% O<sub>2</sub>+14% CO<sub>2</sub>+82.1% N<sub>2</sub>+1% Ar
- 3.7% O<sub>2</sub>+15% CO<sub>2</sub>+80.3% N<sub>2</sub>+1% Ar
- 7% O<sub>2</sub>+12% CO<sub>2</sub>+80% N<sub>2</sub>+1% Ar
- 10% O<sub>2</sub>+9.5% CO<sub>2</sub>+79.5% N<sub>2</sub>+1% Ar
- 13% O<sub>2</sub>+7% CO<sub>2</sub>+79% N<sub>2</sub>+1% Ar

### Chromatography Gas Mixes

- P-5
- P-10

### Laser Gas Mixes

- 4.5% CO<sub>2</sub>+13.5% N<sub>2</sub>+82% He
- 6% CO<sub>2</sub>+14% N<sub>2</sub>+80% He
- 7% CO<sub>2</sub>+14% N<sub>2</sub>+79% He
- 9% CO<sub>2</sub>+15% N<sub>2</sub>+76% He
- 9.4% CO<sub>2</sub>+19.25% N<sub>2</sub>+71.35% He
- 9% Ne+91% He

### Oxygen Concentrator Gas Mixes

- 89% O<sub>2</sub>+7% N<sub>2</sub>+4% Ar
- 93% O<sub>2</sub>+3% N<sub>2</sub>+4% Ar
- 95% O<sub>2</sub>+1% N<sub>2</sub>+4% Ar

### Fuel Gas Mixes

- **Coal Gas** 50% H<sub>2</sub>+35% CH<sub>4</sub>+10% CO+5% C<sub>2</sub>H<sub>4</sub>
- **Endothermic Gas** 75% H<sub>2</sub>+25% N<sub>2</sub>
- **HHO** 66.67% H<sub>2</sub>+33.33% O<sub>2</sub>
- **LPG HD-5** 96.1% C<sub>3</sub>H<sub>8</sub>+1.5% C<sub>2</sub>H<sub>6</sub>+0.4% C<sub>3</sub>H<sub>6</sub>+1.9% n-C<sub>4</sub>H<sub>10</sub>
- **LPG HD-10** 85% C<sub>3</sub>H<sub>8</sub>+10% C<sub>3</sub>H<sub>6</sub>+ 5% n-C<sub>4</sub>H<sub>10</sub>

### Natural Gases

- 93% CH<sub>4</sub>+3% C<sub>2</sub>H<sub>6</sub>+1% C<sub>3</sub>H<sub>8</sub>+2% N<sub>2</sub>+1% CO<sub>2</sub>
- 95% CH<sub>4</sub>+3% C<sub>2</sub>H<sub>6</sub>+1% N<sub>2</sub>+ 1% CO<sub>2</sub>
- 95.2% CH<sub>4</sub>+2.5% C<sub>2</sub>H<sub>6</sub>+0.2% C<sub>3</sub>H<sub>8</sub>+0.1% C<sub>4</sub>H<sub>10</sub>+1.3% N<sub>2</sub>+0.7% CO<sub>2</sub>

### Synthesis Gases

- 40% H<sub>2</sub>+29% CO+20% CO<sub>2</sub>+11% CH<sub>4</sub>
- 64% H<sub>2</sub>+28% CO+1% CO<sub>2</sub>+7% CH<sub>4</sub>
- 70% H<sub>2</sub>+4% CO+25% CO<sub>2</sub>+1% CH<sub>4</sub>
- 83% H<sub>2</sub>+14% CO+3% CH<sub>4</sub>



# Navigating and Customizing Your Flow Meter

## Using COMPOSER™ to Personalize Mixed Gas Compositions

To remain accurate, your flow meter needs to know the viscosity of the gas you are flowing through it. The more closely you can define your actual gas composition, the more accurate your flow readings will be. Alicat's COMPOSER is an included feature of Gas Select that lets you define new mixed gas compositions to reconfigure your flow meter on the fly.

COMPOSER uses the Wilke method to define a new gas mixture based on the molar (volumetric) ratios of the gases in the mixture. You can define these gas compositions to within 0.01% for each of up to five constituent gases in the mixture. Once you define and save a new COMPOSER gas mix, it becomes part of the Gas Select system and is accessible under the gas category **COMPOSER User Mixes**. You can store 20 COMPOSER gas mixes on your flow meter.

✔ **Note: COMPOSER does not physically mix any gases for you. It reconfigures your flow meter to report flow readings more accurately based on the constituents of your defined gas mixture.**

### Gas Select - Category Listing

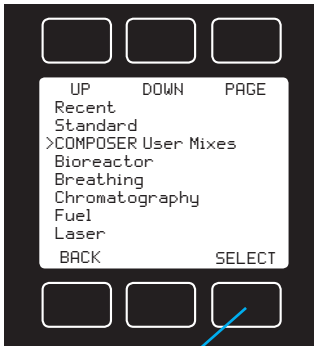

**SELECT** Enters the COMPOSER Menu.

To access COMPOSER, select **COMPOSER User Mixes** from the Gas Select category listing. Select any existing mix to reconfigure your flow meter to flow that gas mixture. Select **Delete Mix** to permanently remove a gas mix.

### Gas Select | COMPOSER Menu

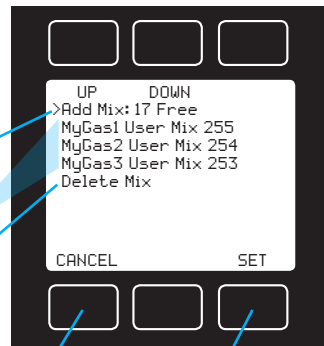

**Add Mix** Creates a new COMPOSER gas mix.

**COMPOSER Mixes** Selects an existing gas mix to use.

**Delete Mix** Deletes an existing gas mix. (Option appears if at least 1 mix exists.)

**CANCEL** Returns to the Gas Select Menu (page 23).

**SET** Confirms your selection and exits to the Main Display (page 17).

# Navigating and Customizing Your Flow Meter

## Adding a new mixed gas composition to COMPOSER

Generate and store a new COMPOSER mix in 3 easy steps.

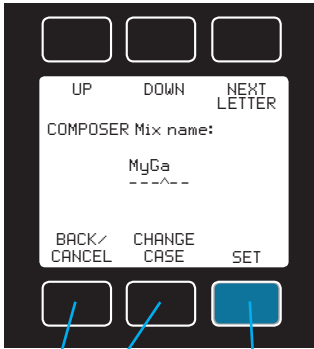

**1 Name the mix.**

**CHANGE CASE**  
Toggles upper/  
lower case.

**SET** Accepts  
the name.

**BACK/CANCEL** Exits  
to the COMPOSER  
Menu.

**CREATE NEW/SIMILAR** Restarts at Step 1.  
After saving a name, **CREATE SIMILAR**  
duplicates the mix you just saved.  
*Note: CREATE SIMILAR is not accessible  
after leaving this screen.*

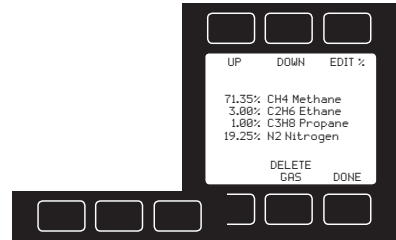

**GAS OPTNS** Edits  
the non-final gas  
mix composition.  
You can delete  
a gas or change  
its composition  
percentage.

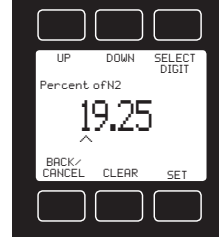

**ADD GAS** Enters Gas Select  
listing to choose a gas,  
then asks you to set its  
composition percentage.

**EDIT NAME** Returns  
to Step 1.

**2 Define  
the mix.**

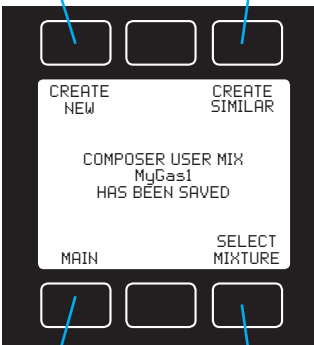

**MAIN** Exits to the Main Display and keeps  
your existing gas selection. **SELECT MIXTURE**  
also activates the new COMPOSER mix.

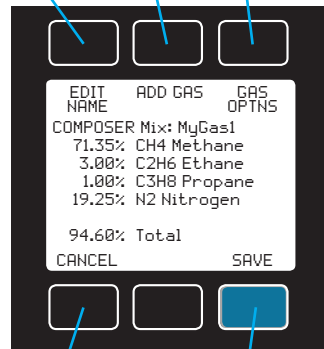

**CANCEL** Exits to the  
COMPOSER Menu.

**SAVE** Adds the new  
mix to COMPOSER.

**3 Save  
the mix.**



**Note: You cannot save your mix  
until the total is 100%. Saved gas  
compositions cannot be changed.**

# Navigating and Customizing Your Flow Meter

## Defining STP/NTP Reference Values

Standardized flow rates are reported in "standard" or "normal" volumetric flow units that reference a given temperature and pressure combination. This reference is called an STP (standard temperature and pressure) or, typically in Europe, an NTP (normal temperature and pressure).

### Basic Configuration | STP/NTP

**Stan T:** Standard Temperature  
**Stan P:** Standard Pressure  
**Norm T:** Normal Temperature  
**Norm P:** Normal Pressure

**Ref temp units** Changes the temperature units used for STP and NTP calculations.

**Ref pressure units** Changes the pressure units used for STP and NTP calculations.

**BACK** Returns to the Basic Configuration Menu (page 22).

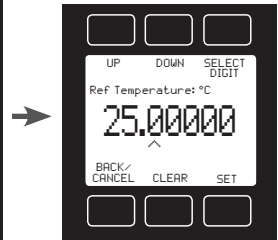
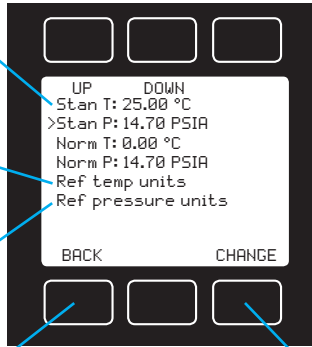

**CHANGE** Enters the value or unit selection screen for the selected parameter.

Using the **STP/NTP** menu, you can independently change the temperature or pressure references for STP and NTP. Your flow meter ships with Alicat default STP of 25°C and 1 atm (which affects flow units beginning with "S"), and an NTP of 0°C and 1 atm (which affects flow units beginning with "N").

To make changes, follow these steps:

1. Select the desired pressure or temperature reference engineering unit by selecting **Ref temp units** or **Ref pressure units** and pressing **CHANGE**. Both normal and standard references use the same engineering units.
2. Select the temperature or pressure value you wish to modify, and press **CHANGE**.
3. At the confirmation screen, press **SET** to confirm your desired change.



**Caution:** Changes to STP/NTP references will alter your mass flow readings.

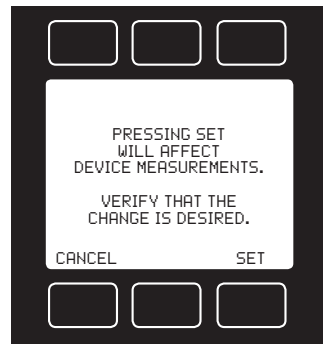

# Navigating and Customizing Your Flow Meter

## Advanced Setup

The Advanced Setup Menu lets you configure the display, deadband, averaging (for flow and pressure) and serial communications.

### Menu | Advanced Setup

**SENSOR SETUP** Enters the Sensor Setup Menu (page 29).

**COMM SETUP** Enters the Communications Menu (page 30).

**DISP SETUP** Enters the Display Setup Menu (below).

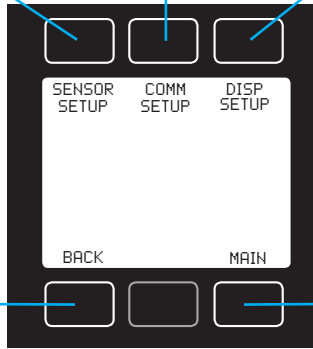

**BACK** Returns to the top-level Menu (page 20).

**MAIN** Exits to the Main Display (page 17).

## Display Setup

The options in the Display Setup Menu adjust the contrast of the display and enable screen rotation.

### Advanced Setup | Display Setup

**LCD CONTRAST** Sets the contrast level of the display. Press reset to revert to the default contrast level.

**ROTATE DISP** Rotates the display and buttons 180° for inverted installations.

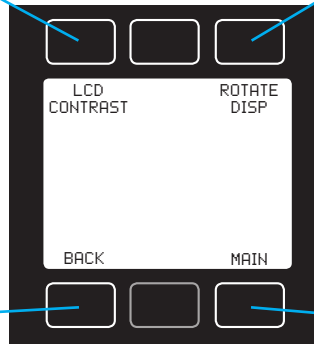
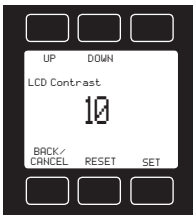

**BACK** Returns to the Setup Menu (above).

**MAIN** Exits to the Main Display (page 17).

# Navigating and Customizing Your Flow Meter

## Sensor Setup

The Sensor Setup Menu contains advanced settings that govern how the flow and pressure sensors report their data.

### Advanced Setup | Sensor Setup

**DISPLAY AS ZERO** Defines the deadband threshold under which flow values are displayed as 0. (Max: 6.38%)

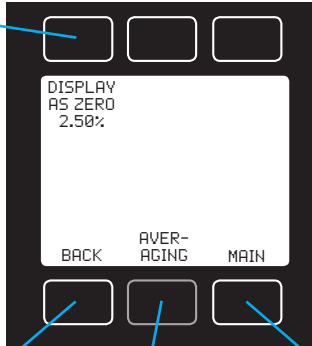
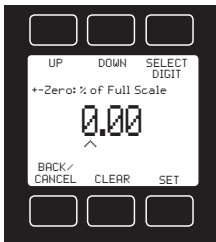

**BACK** Returns to the Advanced Setup Menu (page 28).

**AVERAGING** Adjusts the time constants of the geometric running averages for flow and pressure (1-255 ms).

**MAIN** Exits to the Main Display (page 17).

The deadband threshold (**DISPLAY AS ZERO**) is the value below which the flow meter displays all flow readings as "0" (no flow). This function also applies to gauge pressure readings when using the optional barometer. By default, flow meters ship with a deadband value of 0.25%, so on a 20-slp instrument, all readings below 0.05 slpm would display as 0 slpm.

✓ **Note:** Deadband settings do not affect the values reported in the serial data frame.

The **AVERAGING** button opens a submenu for adjusting the flow and pressure averaging, which are changed independently. Values roughly correspond to the time constant (in milliseconds) of the averaged values. Higher numbers generate a greater smoothing effect on rapidly fluctuating readings (max 255 ms).

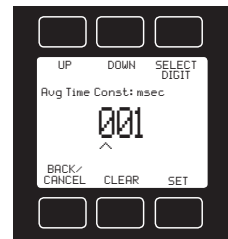

# Navigating and Customizing Your Flow Meter

## Configuring Your Flow Meter for Serial Communications

You can operate the flow meter remotely via its top connector for easy streaming and logging of all data. Before connecting the flow meter to a computer, ensure that it is ready to communicate with your PC by checking the options in the **COMM SETUP** menu.

### Advanced Setup | Comm Setup

**UNIT ID** Sets the serial unit ID (below):

@ = streaming mode  
A-Z = polling mode

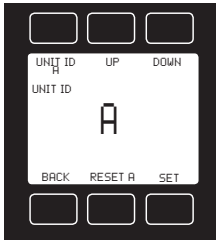

**BACK** Returns to the Advanced Setup Menu (page 28).

**BAUD** Sets the serial baud rate (below). Baud rates include: 2400, 9600, 19200 and 38400.

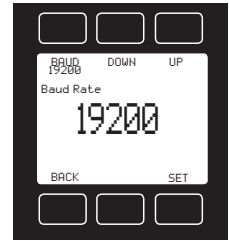
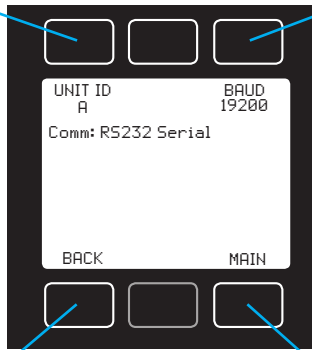

**MAIN** Exits to the Main Display (page 17).

### Unit ID

The unit ID is the identifier that a computer uses to distinguish your flow meter from other Alicat devices when it is connected to a network. Using the unit ID letters **A-Z**, you can connect up to 26 devices to a computer at the same time via a single COM port. This is called polling mode (page 32). Unit ID changes take effect when you select **SET**.

If you select @ as the Unit ID, the flow meter enters streaming mode when you exit the menu (see page 32).

### Baud Rate

Baud rate is the speed at which digital devices transfer information. The flow meter has a default baud rate of 19200 baud (bits per second). If your computer or software uses a different baud rate, you must change the flow meter baud rate in the **BAUD** menu to match them both. Alternatively, you can change your PC's baud rate in Device Manager. Baud rate changes take effect once you press **SET**, but you may need to restart your software.

# Serial Communications

Connecting your flow meter to a computer allows you to log the data that it generates. The flow meter communicates digitally through its communications connector and cable using a real or virtual COM port on your PC. This section of the manual shows you how to operate the flow meter using ASCII commands.

## Establishing Serial Communications

After connecting your flow meter using a communications cable, you will need to establish serial communications through a real or virtual COM port on your computer or PLC.

- If you have connected your device to a serial port, note its COM port number. This can be found in Windows Device Manager.
- If you have used a USB cable to connect your device to your computer, the computer in most cases will recognize your Alicat as a virtual COM port. If it does not, download the appropriate USB device driver at [alicat.com/drivers](http://alicat.com/drivers) and note the COM port number as found in Windows Device Manager.

### Serial Terminal Application

Alicat's Serial Terminal is a preconfigured program for serial communications that functions much like the older HyperTerminal program of Windows. Download Serial Terminal for free at [alicat.com/drivers](http://alicat.com/drivers). Once downloaded, simply run SerialTerminal.exe. Enter the COM port number to which your device is connected and the baud rate of the flow meter. The default baud rate is 19200, but this is adjustable by entering the **SERIAL COMM** menu on your flow meter: **MENU > ADV SETUP > COMM SETUP > BAUD** (page 30).

# Serial Communications

## Serial Streaming vs Polling

✔ *Note: In what follows, <CR> indicates an ASCII carriage return (decimal 13, hexadecimal D). Serial commands are not case-sensitive.*

### Polling Mode

Your flow meter was shipped to you in polling mode with a unit ID of A, unless requested otherwise. Polling the flow meter returns a single line of data each time you request it. To poll your flow meter, simply enter its unit ID.

**Poll the device:** [unit ID]<CR>

**Example:** a<CR> (polls unit A)

You can change the unit ID of a polling device by typing:

**Change the unit ID:** [current unit ID]@[desired unit ID]<CR>

**Example:** a@=b<CR> (changes unit A to unit B)

You can also do this via the flow meter menu: **MENU > ADV SETUP > COMM SETUP > UNIT ID** (page 30). Valid unit IDs are letters A-Z, and up to 26 devices may be connected at any one time, as long as each unit ID is unique.

### Streaming Mode

In streaming mode, your flow meter continuously sends a line of live data at regular intervals without your having to request the data each time. Only one unit on a given COM port may be in streaming mode at a time.

To put your flow meter into streaming mode, type:

**Begin streaming:** [unit ID]@=@<CR>

This is equivalent to changing the unit ID to "@". To take the flow meter out of streaming mode, assign it a unit ID by typing:

**Stop streaming:** @@=[desired unit ID]<CR>

**Example:** @@=a<CR> (stops and assigns unit ID of A)

When sending a command to a flow meter in streaming mode, the flow of data will not stop while the user is typing. This may make the commands you type unreadable. If the device does not receive a valid command, it will ignore it. If in doubt, simply hit <CR> and start again.

✔ *Note: The default streaming interval is 50 ms, but this can be increased by changing Register 91 while the device is in polling mode:*

**Set streaming interval:** [unit ID] w91=[number of milliseconds]<CR>

**Example:** aw91=500<CR> (streams new data every 500 ms)



# Serial Communications

## Taring Serially

Before collecting flow data, be sure to tare your flow meter. This can occur serially through two separate commands. Taring flow sets the zero flow reading and must be done when no flow is passing through the flow meter:

**Tare flow:** [unit ID]v<CR>  
**Example:** av<CR> (sets flow reading to zero)

For devices equipped with a barometer, the second tare aligns the internal absolute pressure sensor with the current barometer reading and must be done with the flow meter open to atmosphere:

**Tare absolute pressure:** [unit ID]pc<CR>  
**Example:** apc<CR> (aligns internal pressure to barometer)

## Collecting Flow Data Serially

Collect live flow data by typing the [unit ID] <CR> command or by setting your flow meter to streaming. Each line of data for live flow measurements appears in the format below, but Unit ID is not present in streaming mode.

A	+13.60	+24.38	+16.67	+15.44	Air
	Absolute Pressure	Temperature	Volumetric Flow	Standard (Mass) Flow	Gas
Unit ID					

Single spaces separate each parameter, and each value is displayed in the chosen device engineering units, which may differ from the engineering units visible on the flow meter display (see "Choosing Engineering Units" on page 18). You can query the engineering units of the instant data frame by typing:

**Query live data info:** [unit ID]??d\*<CR>  
**Example:** a??d\*<CR> (returns the data frame descriptions)

Additional columns, including status codes (see "Status Messages" on page 8), may be present to the right of the gas label column. The Unit ID appears in the data frame only when the flow meter is in polling mode.

# Serial Communications

## Quick Serial Command Guide



*Note: Serial commands are not case-sensitive. For simplicity, we assume that the unit ID of the flow meter is A in the listing that follows.*

<i>Change the unit ID:</i>	[current unit ID]@[desired unit ID]<CR>
<i>Tare flow:</i>	av<CR>
<i>Tare abs. pressure with baro:</i>	apc<CR> (optional)
<i>Poll the live data frame:</i>	a<CR>
<i>Begin streaming data:</i>	[unit ID]@=@<CR>
<i>Stop streaming data:</i>	@@=[desired unit ID]<CR>
<i>Set streaming interval:</i>	aw91=[number of milliseconds]<CR>
<i>Query gas list info:</i>	a??g*<CR>
<i>Choose a different gas:</i>	ag[Gas Number]<CR>
<i>Create a COMPOSER mix:</i>	
agm [Mix Name] [Mix Number] [Gas1 %] [Gas1 Number] [Gas2 %] [Gas2 Number]...<CR>	
<i>Delete a COMPOSER mix:</i>	agd [Mix Number]<CR>
<i>Query live data info:</i>	a??d*<CR>
<i>Query manufacturer info:</i>	a??m*<CR>
<i>Query firmware version:</i>	a??m9<CR>
<i>Lock the front display:</i>	a1<CR>
<i>Unlock the front display:</i>	au<CR>

If you have need of more advanced serial communication commands, please contact Alicat.

# Serial Communications

## Using Gas Select and COMPOSER Serially

To reconfigure your flow meter to flow a different gas, look up its Gas Number (see "Numerical List of Gases" on page 48). Then type:

**Choose a gas:** [unit ID]g[Gas Number]<CR>

**Example 1:** ag8<CR> (reconfigures to flow nitrogen)

**Example 2:** ag206<CR> (reconfigures to flow P-10)

COMPOSER user mixes are selected in the same way. All COMPOSER gas mixes have a Gas Number between 236 and 255.

**Choose a user mix:** [unit ID]g[Gas Number]<CR>

**Example:** ag255<CR> (reconfigures for user mix 255)

Defining a new COMPOSER gas mix is faster using serial commands than using the front panel. The basic formula for this is:

[unit ID]gm [Mix Name] [Mix Number] [Gas1 %] [Gas1 Number] [Gas2 %] [Gas2 Number]...<CR>

» [Mix Name] Use a maximum of 6 letters (upper case and/or lower case), numbers and symbols (space, period or hyphen only).

» [Mix Number] Choose a number from 236 to 255. If a user mix with that number already exists, it will be overwritten. Use the number 0 to assign the next available number to your new gas. **Note: COMPOSER gas numbers are assigned in descending order from 255.**

» [Gas1 %] [Gas1 Number]... For each constituent gas, enter its molar percentage (using up to 2 decimal places) and then its Gas Number (page 48). You must have at least 2—but no more than 5—gases in your COMPOSER mix.

After creating your COMPOSER mix, your flow meter will confirm the new gas:

**Example 1:** Create a mix of 71.35% helium, 19.25% nitrogen and 9.4% carbon dioxide as Gas 252, called "MyGas1".

agm MyGas1 252 71.35 7 19.25 8 9.4 4<CR>

**Response:** A 252 71.35% He 19.25% N2 9.40% CO2

**Example 2:** Create a mix of 93% methane, 3% ethane, 1% propane, 2% nitrogen and 1% carbon dioxide, using the next available gas number, called "MyGas2".

agm MyGas2 0 93 2 3 5 1 12 2 8 1 4<CR>

**Response:** A 253 93.00% CH4 3.00% C2H6 1.00% C3H8 2.00% N2 1.00% CO2



**Note:** The sum of all gas constituent percentages must equal 100.00%.

# Troubleshooting Your Flow Meter

If you run into any trouble with your Alicat's installation or operation, please get in touch with us by phone, chat or email. You'll also find help on our website [alicat.com](http://alicat.com) and in the pages that follow.

## General Use

**Issue:** *My Alicat does not turn on or is weak.*

**Action:** Check power and ground connections. Please reference the technical specifications to assure you have the proper power for your model.

Portable flow meters run on a rechargeable battery, but you can also connect to a wall outlet or computer using a micro-USB cable. If the battery has been fully depleted, it may take a minute or so to acquire enough charge to turn back on. If your flow meter will not power on after being plugged in for at least 5 minutes, contact Alicat.

**Issue:** *The buttons do not work, and the screen shows LCK.*

**Action:** The flow meter buttons were locked out via a serial command. Press and hold all four outer buttons to unlock the interface.

**Issue:** *I can't read the display easily.*

**Action:** During the day, you can increase the visibility of the display by increasing the contrast (**MENU > ADV SETUP > DISP SETUP > LCD CONTRAST**). If you are working under low-light conditions, push the large Alicat button (located below the display) to turn on the backlight.

**Issue:** *How often do I need to calibrate my Alicat?*

**Action:** Alicat recommends annual recalibrations. Check your flow meter's last calibration date by selecting **MENU > ABOUT > DEVICE INFO**. If it is time to recalibrate, request a recalibration at [alicat.com/service](http://alicat.com/service).

**Issue:** *I dropped my Alicat. Is it ok? Do I need to recalibrate?*

**Action:** If it turns on and appears to respond normally, then it is probably ok. It may or may not need a recalibration. Compare it against a known-good flow standard. If it checks out, keep using it, but tell us about the drop at your next annual recalibration so we can check it out for you.

## Temperature Readings

**Issue:** *How can I see temperature in different units?*

**Action:** From the Main Display, press the button above the temperature reading twice, and then choose **Set button eng units**. Use the **UP/DOWN** keys to move the > cursor to the desired unit, and then press **SET**.

On portable devices, charging the device may also resolve the issue.

# Troubleshooting Your Flow Meter

## Pressure Readings

**Issue:** *How can I see pressure in different units?*

**Action:** From the Main Display, press the button above the pressure reading twice, and then choose **Set button eng units**. Use the **UP/DOWN** keys to move the > cursor to the desired unit, and then press **SET**.

## Flow Readings

**Issue:** *How can I see flow in different units?*

**Action:** From the Main Display, press the button below the flow reading twice, and then choose **Set button eng units**. Use the **UP/DOWN** keys to move the > cursor to the desired unit, and then press **SET**.

**Issue:** *The live flow readings won't settle down.*

**Action:** The flow meter is very fast, so it can detect subtle variations in flow that may go unnoticed by your other flow devices. This sensitivity can help detect problems with pumps or flow controllers. You can lessen this sensitivity by decreasing the flow averaging (press **MENU > ADV SETUP > SENSOR SETUP > FLOW AVG**

**Issue:** *My flow readings are negative.*

**Action:** If your flow meter is not connected to anything, it may be reading a small flow that is entering its outlet. Plug one end to see if the flow returns to 0. Under conditions of no flow, a negative flow reading can indicate a poor tare. Ensure that the flow meter has no flow passing through it, and select **TARE FLOW** from the Main Display to give it a fresh tare.

**Issue:** *Does the Alicat work if it is laying down? Will it be accurate?*

**Action:** Yes to both! The flow meter is internally compensated for any changes in orientation, so you can use it sideways, on its back, or upside-down. S and QS-series devices should be tared again after changing their orientation.

**Issue:** *Can I put the Alicat on top of a vibrating device? Will it be accurate?*

**Action:** Yes, and yes! The flow meter is internally compensated for any changes in orientation, including rapid vibrations. Noise will increase if the flow meter is vibrating.

**Issue:** *My meter does not agree with another meter I have in line.*

**Action:** Check the STP or NTP settings (**MENU > BASIC CONFIG > STP/NTP**) to ensure that your standardized temperature and pressure references match those of your other flow calibrator. Also check that your device's Gas Select is set to the right gas or mixture.

**Issue:** *My flow readings won't change when flow changes.*

**Action:** If your flow readings won't change regardless of actual flow, your flow sensor may be damaged. Please contact Alicat to troubleshoot.

# Troubleshooting Your Flow Meter

**Issue:** *Can I use the Alicat with other gases?*

**Action:** Yes! Your flow meter is designed specifically to work with many different gases. Gas Select (**MENU > BASIC CONFIG > GAS**) includes up to 130 preloaded gases and gas mixes, or you can define your own using COMPOSER. If your desired gas is not listed, please contact Alicat to ensure compatibility.

## Serial Communications

**Issue:** *I can't communicate to the Alicat when it is connected to my PC.*

**Action:** Make sure the COM number matches the one your software is using to connect to the flow meter. Check the flow meter unit ID (**MENU > ADV SETUP > COMM SETUP > UNIT ID**) to make sure you are addressing it properly with your serial commands. Make sure the baud rate your software and Com Port require is the one your flow meter is using (**MENU > ADV SETUP > COMM SETUP > BAUD**).

## Still experiencing issues?

**Issue:** *None of the above helped.*

**Action:** We're here to help! Give us a call (1-888-290-6060) during our normal business hours (8am-5pm Mountain Standard Time) to get help from a friendly and capable applications engineer. Or, go to [alicat.com](http://alicat.com) and start a live chat. Is it after hours? Send an email to [info@alicat.com](mailto:info@alicat.com), and we'll get in touch with you as soon as we can.

Additionally, we our troubleshooting page online might be more up to date than the manual. Please visit [alicat.com/ssupport](http://alicat.com/ssupport).

# Maintenance and Recalibration

## Cleaning

Your flow meter requires no periodic cleaning, provided that it has been flowing clean, dry gas. If necessary, the outside of the device can be cleaned with a soft dry cloth.



*If you suspect that debris or other foreign material has entered your device, do not take apart the flow body to clean it, as this will negate its NIST-traceable calibration. Please contact Alicat for cleaning.*

## Recalibration

The recommended period for recalibration is once every year. A label located on the back of the device lists the most recent calibration date. This date is also stored inside your flow meter and is visible by selecting **MENU > ABOUT > DEVICE INFO**.

When it is time for your flow meter's annual recalibration, contact us by phone or live chat to set it up. Or, send an email to [service@alicat.com](mailto:service@alicat.com), or fill out the form at [alicat.com/service](http://alicat.com/service). We'll ask for your device's serial number and your contact information and send you an email with instructions for returning the flow meter to us.

## Replacement Accessories

Please contact Alicat to order replacements for any accessories listed on page 53:

For repair, recalibration or recycling of this product contact:

**Alicat Scientific, Inc.**

[service@alicat.com](mailto:service@alicat.com) • [alicat.com](http://alicat.com)

7641 N Business Park Drive Tucson, AZ 85743 USA

1-888-290-6060

# Gas Properties Data

PURE NON-CORROSIVE GASES								
Gas Number	Short Name	Long Name	25°C			0°C		
			Absolute Viscosity*	Density**	Compressibility	Absolute Viscosity	Density	Compressibility
			14.696 PSIA	14.696 PSIA	14.696 PSIA	14.696 PSIA	14.696 PSIA	
14	C2H2	Acetylene	104.44800	1.07200	0.9928000	97.374	1.1728	0.9905
0	Air	Air	184.89890	1.18402	0.9996967	172.574	1.2930	0.9994
1	Ar	Argon	226.23990	1.63387	0.9993656	210.167	1.7840	0.9991
16	i-C4H10	i-Butane	74.97846	2.44028	0.9735331	68.759	2.6887	0.9645
13	n-C4H10	n-Butane	74.05358	2.44930	0.9699493	67.690	2.7037	0.9591
4	CO2	Carbon Dioxide	149.31840	1.80798	0.9949545	137.107	1.9768	0.9933
3	CO	Carbon Monoxide	176.49330	1.14530	0.9996406	165.151	1.2505	0.9993
60	D2	Deuterium	126.59836	0.16455	1.0005970	119.196	0.1796	1.0006
5	C2H6	Ethane	93.54117	1.23846	0.9923987	86.129	1.3550	0.9901
15	C2H4	Ethylene (Ethene)	103.18390	1.15329	0.9942550	94.697	1.2611	0.9925
7	He	Helium	198.45610	0.16353	1.0004720	186.945	0.1785	1.0005
6	H2	Hydrogen	89.15355	0.08235	1.0005940	83.969	0.0899	1.0006
17	Kr	Krypton	251.32490	3.43229	0.9979266	232.193	3.7490	0.9972
2	CH4	Methane	110.75950	0.65688	0.9982472	102.550	0.7175	0.9976
10	Ne	Neon	311.12640	0.82442	1.0004810	293.822	0.8999	1.0005
8	N2	Nitrogen	178.04740	1.14525	0.9998016	166.287	1.2504	0.9995
9	N2O	Nitrous Oxide	148.41240	1.80888	0.9945327	136.310	1.9779	0.9928
11	O2	Oxygen	205.50210	1.30879	0.9993530	191.433	1.4290	0.9990
12	C3H8	Propane	81.46309	1.83204	0.9838054	74.692	2.0105	0.9785
19	SF6	Sulfur Hexafluoride	153.53200	6.03832	0.9886681	140.890	6.6162	0.9849
18	Xe	Xenon	229.84830	5.39502	0.9947117	212.157	5.8980	0.9932

**\*in micropoise (1 Poise = gram / (cm) (sec))      \*\*Grams/Liter      Reference: NIST REFPROP 9 Database**



PURE CORROSIVES*			25°C				0°C				
Gas Number	Short Name	Long Name	Absolute Viscosity*	Density**	Compressibility	Absolute Viscosity	Density	Compressibility	Absolute Viscosity	Density	Compressibility
			14.696 PSIA	14.696 PSIA	14.696 PSIA	14.696 PSIA	14.696 PSIA	14.696 PSIA	14.696 PSIA	14.696 PSIA	14.696 PSIA
32	NH3	Ammonia	100.92580	0.70352	0.9894555	91.930	0.7715	0.9848612	74.354	2.6036	0.9614456
80	1Butene	Butylene (1-Butene)	81.62541	2.35906	0.9721251	Liquid	Liquid	Liquid	Liquid	Liquid	Liquid
81	cButene	Cis-Butene (cis-2-butene)	79.96139	2.36608	0.9692405	73.640	2.6038	0.9613501	73.640	2.6038	0.9613501
82	iButene	Iso-Butene	80.84175	2.35897	0.9721626	Liquid	Liquid	Liquid	Liquid	Liquid	Liquid
83	tButene	Trans-Butene	80.28018	2.36596	0.9692902	113.127	2.7202	0.985328	113.127	2.7202	0.985328
84	COS	Carbonyl Sulfide	124.09600	2.48322	0.9888443	125.464	3.1635	0.98407	125.464	3.1635	0.98407
33	Cl2	Chlorine	134.56600	2.93506	0.9874470	82.865	2.1090	0.9745473	82.865	2.1090	0.9745473
85	CH3OCH3	Dimethylether	90.99451	1.91822	0.9816453	112.982	1.5361	0.9898858	112.982	1.5361	0.9898858
34	H2S	Hydrogen Sulfide (H2S)	123.86890	1.40376	0.9923556	162.426	3.1840	0.9951506	162.426	3.1840	0.9951506
31	NF3	NF3 (Nitrogen Trifluoride)	175.42500	2.91339	0.9963859	176.754	1.3394	0.9995317	176.754	1.3394	0.9995317
30	NO	NO (Nitric Oxide)	190.05950	1.22672	0.9997970	78.129	1.9139	0.9809373	78.129	1.9139	0.9809373
36	C3H6	Propylene (Propylene)	85.59895	1.74509	0.9856064	107.053	1.4433	0.99282	107.053	1.4433	0.99282
86	SiH4	Silane (SiH4)	115.94400	1.32003	0.9945000	116.717	2.9312	0.9750866	116.717	2.9312	0.9750866
35	SO2	Sulfur Dioxide	127.83100	2.66427	0.9828407						

\*Pure Corrosive gases are only available on S-Series instruments that are compatible with these gases.

\*in micropoise (1 Poise = gram / (cm) (sec)) \*\*Grams/Liter Reference: NIST REFPROP 9 Database

REFRIGERANTS			25°C				0°C			
Gas Number	Short Name	Long Name	Absolute Viscosity*	Density** 14.696 PSIA	Compressibility 14.696 PSIA	Absolute Viscosity	Density 14.696 PSIA	Compressibility 14.696 PSIA		
100	R-11	Trichlorofluoromethane	101.60480	5.82358	0.9641448	Liquid	Liquid	Liquid		
101	R-115	Chloropentafluoroethane	125.14780	6.43293	0.9814628	114.891	7.0666	0.9752287		
102	R-116	Hexafluoroethane	137.81730	5.70097	0.9895011	126.635	6.2458	0.9858448		
103	R-124	Chlorotetrafluoroethane	115.93110	5.72821	0.9738286	105.808	6.3175	0.963807		
104	R-125	Pentafluoroethane	129.61740	4.98169	0.9847599	118.793	5.4689	0.979137		
105	R-134A	Tetrafluoroethane	118.18820	4.25784	0.9794810	108.311	4.6863	0.9713825		
106	R-14	Tetrafluoromethane	172.44680	3.61084	0.9962553	159.688	3.9467	0.9948964		
107	R142B	Chlorodifluoroethane	104.20190	4.21632	0.9742264	95.092	4.6509	0.9640371		
108	R-143A	Trifluoroethane	110.86600	3.49451	0.9830011	101.344	3.8394	0.9765755		
109	R-152A	Difluoroethane	100.81320	2.75903	0.9785245	91.952	3.0377	0.9701025		
110	R-22	NO (Nitric Oxide)	190.05950	1.22672	0.9997970	176.754	1.3394	0.9995317		
111	R-23	Propylene (Propylene)	85.59895	1.74509	0.9856064	78.129	1.9139	0.9809373		
112	R32	Silane (SiH4)	115.94400	1.32003	0.9945000	107.053	1.4433	0.99282		
113	RC-318	Sulfur Dioxide	127.83100	2.66427	0.9828407	116.717	2.9312	0.9750866		
114	R-404A	44% R-125/4% R-134A/ 52% R-143A	120.30982	4.18002	0.98336342	111.584	4.5932	0.9770889		
115	R-407C	23% R-32/25% R-125/ 52% R-143A	123.55369	3.95268	0.9826672	112.698	4.3427	0.9762849		
116	R-410A	50% R-32/50% R-125	130.24384	3.56538	0.9861780	122.417	3.9118	0.9811061		
117	R-507A	50% R-125/50% R-143A	121.18202	4.23867	0.9838805	112.445	4.6573	0.9774207		

\*Refrigerant gases are only available on S-Series instruments that are compatible with these gases.

WELDING GASES		Long Name	25°C			0°C		
Gas Number	Short Name		Absolute Viscosity*	Density** 14.696 PSIA	Compressibility 14.696 PSIA	Absolute Viscosity	Density 14.696 PSIA	Compressibility 14.696 PSIA
23	C-2	2% CO2 / 98% Ar	224.71480	1.63727	0.9993165	208.673	1.7877	0.998993
22	C-8	8% CO2 / 92% Ar	220.13520	1.64749	0.9991624	204.199	1.7989	0.9987964
21	C-10	10% CO2 / 90% Ar	218.60260	1.65091	0.9991086	202.706	1.8027	0.9987278
140	C-15	15% CO2 / 85% Ar	214.74960	1.65945	0.9989687	198.960	1.8121	0.9985493
141	C-20	20% CO2 / 80% Ar	210.86960	1.66800	0.9988210	195.198	1.8215	0.9983605
20	C-25	25% CO2 / 75% Ar	206.97630	1.67658	0.9986652	191.436	1.8309	0.9981609
142	C-50	50% CO2 / 50% Ar	187.53160	1.71972	0.9977484	172.843	1.8786	0.9969777
24	C-75	75% CO2 / 25% Ar	168.22500	1.76344	0.9965484	154.670	1.9271	0.995401
25	He-25	25% He / 75% Ar	231.60563	1.26598	0.9996422	216.008	1.3814	0.9999341
143	He-50	50% He / 50% Ar	236.15149	0.89829	0.9999188	220.464	0.9800	1.00039
26	He-75	75% He / 25% Ar	234.68601	0.53081	1.0001954	216.937	0.5792	1.000571
144	He-90	90% He / 10% Ar	222.14566	0.31041	1.0003614	205.813	0.3388	1.00057
27	A1025	90%He/7.5%Ar/2.5%CO2	214.97608	0.31460	1.0002511	201.175	0.3433	1.000556
28	Star29	Stargon CS 90% Ar / 8% CO2 / 2% O2	219.79340	1.64099	0.9991638	203.890	1.7918	0.998798
*in micropoise (1 Poise = gram / (cm) (sec))			**Grams/Liter			Reference: NIST REFPROP 9 Database		

BIOREACTOR GASES			25 °C			0 °C		
Gas Number	Short Name	Long Name	Absolute Viscosity*	Density** 14.696 PSIA	Compressibility 14.696 PSIA	Absolute Viscosity	Density 14.696 PSIA	Compressibility 14.696 PSIA
145	Bio-5M	5% CH4 / 95% CO2	148.46635	1.75026	0.9951191	136.268	1.9134	0.9935816
146	Bio-10M	10% CH4 / 90% CO2	147.54809	1.69254	0.9952838	135.383	1.8500	0.993893
147	Bio-15M	15% CH4 / 85% CO2	146.55859	1.63484	0.9954484	134.447	1.7867	0.9941932
148	Bio-20M	20% CH4 / 80% CO2	145.49238	1.57716	0.9956130	133.457	1.7235	0.994482
149	Bio-25M	25% CH4 / 75% CO2	144.34349	1.51950	0.9957777	132.407	1.6603	0.9947594
150	Bio-30M	30% CH4 / 70% CO2	143.10541	1.46186	0.9959423	131.290	1.5971	0.9950255
151	Bio-35M	35% CH4 / 65% CO2	141.77101	1.40424	0.9961069	130.102	1.5340	0.9952803
152	Bio-40M	40% CH4 / 60% CO2	140.33250	1.34664	0.9962716	128.834	1.4710	0.9955239
153	Bio-45M	45% CH4 / 55% CO2	138.78134	1.28905	0.9964362	127.478	1.4080	0.9957564
154	Bio-50M	50% CH4 / 50% CO2	137.10815	1.23149	0.9966009	126.025	1.3450	0.9959779
155	Bio-55M	55% CH4 / 45% CO2	135.30261	1.17394	0.9967655	124.462	1.2821	0.9961886
156	Bio-60M	60% CH4 / 40% CO2	133.35338	1.11642	0.9969301	122.779	1.2193	0.9963885
157	Bio-65M	65% CH4 / 35% CO2	131.24791	1.05891	0.9970948	120.959	1.1564	0.9965779
158	Bio-70M	70% CH4 / 30% CO2	128.97238	1.00142	0.9972594	118.987	1.0936	0.9967567
159	Bio-75M	75% CH4 / 25% CO2	126.51146	0.94395	0.9974240	116.842	1.0309	0.9969251
160	Bio-80M	80% CH4 / 20% CO2	123.84817	0.88650	0.9975887	114.501	0.9681	0.9970832
161	Bio-85M	85% CH4 / 15% CO2	120.96360	0.82907	0.9977533	111.938	0.9054	0.9972309
162	Bio-90M	90% CH4 / 10% CO2	117.83674	0.77166	0.9979179	109.119	0.8427	0.9973684
163	Bio-95M	95% CH4 / 5% CO2	114.44413	0.71426	0.9980826	106.005	0.7801	0.9974957

Reference: NIST REFPROP 9 Database

\*in micropoise (1 Poise = gram / (cm) (sec))      \*\*Grams/Liter

BREATHING GASES			25 °C				0 °C		
Gas Number	Short Name	Long Name	Absolute Viscosity*	Density** 14.696 PSIA	Compressibility 14.696 PSIA	Absolute Viscosity	Density 14.696 PSIA	Compressibility 14.696 PSIA	
164	EAN-32	32% O2 / 68% N2	186.86315	1.19757	0.9996580	174.925	1.3075	0.9993715	
165	EAN	36% O2 / 64% N2	187.96313	1.20411	0.9996401	175.963	1.3147	0.9993508	
166	EAN-40	40% O2 / 60% N2	189.06268	1.21065	0.9996222	176.993	1.3218	0.9993302	
167	HeOx-20	20% O2 / 80% He	217.88794	0.39237	1.0002482	204.175	0.4281	1.000593	
168	HeOx-21	21% O2 / 79% He	218.15984	0.40382	1.0002370	204.395	0.4406	1.000591	
169	HeOx-30	30% O2 / 70% He	219.24536	0.50683	1.0001363	205.140	0.5530	1.000565	
170	HeOx-40	40% O2 / 60% He	218.59913	0.62132	1.0000244	204.307	0.6779	1.000502	
171	HeOx-50	50% O2 / 50% He	216.95310	0.73583	0.9999125	202.592	0.8028	1.000401	
172	HeOx-60	60% O2 / 40% He	214.82626	0.85037	0.9998006	200.467	0.9278	1.000257	
173	HeOx-80	80% O2 / 20% He	210.11726	1.07952	0.9995768	195.872	1.1781	0.9998019	
174	HeOx-99	99% O2 / 1% He	205.72469	1.29731	0.9993642	191.646	1.4165	0.9990796	
175	EA-40	Enriched Air-40% O2	189.42518	1.21429	0.9996177	177.396	1.3258	0.9993261	
176	EA-60	Enriched Air-60% O2	194.79159	1.24578	0.9995295	182.261	1.3602	0.9992266	
177	EA-80	Enriched Air-80% O2	200.15060	1.27727	0.9994412	186.937	1.3946	0.9991288	
178	Metabol	Metabolic Exhalant (16% O2 / 78.04% N2 / 5% CO2 / 0.96% Ar)	180.95936	1.20909	0.9994833	170.051	1.3200	0.9992587	

Reference: NIST REFPROP 9 Database

\*\*Grams/Liter

\*in micropoise (1 Poise = gram / (cm) (sec))

FUEL GASES			25°C				0°C		
Gas Number	Short Name	Long Name	Absolute Viscosity*	Density** 14.696 PSIA	Compressibility 14.696 PSIA	Absolute Viscosity	Density 14.696 PSIA	Compressibility 14.696 PSIA	
185	Syn Gas-1	40% H2 + 29% CO + 20% CO2 + 11% CH4	155.64744	0.79774	0.9989315	144.565	0.8704	0.9992763	
186	Syn Gas-2	64% H2 + 28% CO + 1% CO2 + 7% CH4	151.98915	0.43715	1.0001064	142.249	0.4771	1.000263	
187	Syn Gas-3	70% H2 + 4% CO + 25% CO2 + 1% CH4	147.33686	0.56024	0.9991225	136.493	0.6111	0.9997559	
188	Syn Gas-4	83% H2 + 14% CO + 3% CH4	133.63682	0.24825	1.0003901	125.388	0.2709	1.000509	
189	Nat Gas-1	93% CH4 / 3% C2H6 / 1% C3H8 / 2% N2 / 1% CO2	111.77027	0.70709	0.9979255	103.189	0.7722	0.9973965	
190	Nat Gas-2	95% CH4 / 3% C2H6 / 1% N2 / 1% CO2	111.55570	0.69061	0.9980544	103.027	0.7543	0.9974642	
191	Nat Gas-3	95.2% CH4 / 2.5% C2H6 / 0.2% C3H8 / 0.1% C4H10 / 1.3% N2 / 0.7% CO2	111.49608	0.68980	0.9980410	102.980	0.7534	0.9974725	
192	Coal Gas	50% H2 / 35% CH4 / 10% CO / 5% C2H4	123.68517	0.44281	0.9993603	115.045	0.6589	0.996387	
193	Endo	75% H2 + 25% N2	141.72100	0.34787	1.0005210	133.088	0.3797	1.000511	
194	HHO	66.67% H2 / 33.33% O2	180.46190	0.49078	1.0001804	168.664	0.5356	1.000396	
195	HD-5	LPG 96.1% C3H8 / 1.5% C2H6 / 0.4% C3H6 / 1.9% n-C4H10	81.45829	1.83428	0.9836781	74.933	2.0128	0.9784565	
196	HD-10	LPG 85% C3H8 / 10% C3H6 / 5% n-C4H10	81.41997	1.85378	0.9832927	74.934	2.0343	0.9780499	

LASER GASES			25°C			0°C		
Gas Number	Short Name	Long Name	Absolute Viscosity*	Density** 14.696 PSIA	Compressibility 14.696 PSIA	Absolute Viscosity	Density 14.696 PSIA	Compressibility 14.696 PSIA
179	LG-4-5	4.5% CO2 / 13.5% N2 / 82% He	199.24300	0.36963	1.0001332	187.438	0.4033	1.000551
180	LG-6	6% CO2 / 14% N2 / 80% He	197.87765	0.39910	1.0000471	186.670	0.4354	1.00053
181	LG-7	7% CO2 / 14% N2 / 79% He	197.00519	0.41548	0.9999919	186.204	0.4533	1.000514
182	LG-9	9% CO2 / 15% N2 / 76% He	195.06655	0.45805	0.9998749	184.835	0.4997	1.000478
183	HeNe-9	9% Ne / 91% He	224.68017	0.22301	1.0004728	211.756	0.2276	1.000516
184	LG-9.4	9.4% CO2 / 19.25% N2 / 71.35% He	193.78311	0.50633	0.9998243	183.261	0.5523	1.000458

\*in micropoise (1 Poise = gram / (cm) (sec))      \*\*Grams/Liter      Reference: NIST REFPROP 9 Database

O2 CONCENTRATOR GASES				25°C		0°C		
Gas Number	Short Name	Long Name	Absolute Viscosity*	Density** 14.696 PSIA	Compressibility 14.696 PSIA	Absolute Viscosity	Density 14.696 PSIA	Compressibility 14.696 PSIA
197	OCG-89	89% O2 / 7% N2 / 4% Ar	204.53313	1.31033	0.9993849	190.897	1.4307	0.9990695
198	OCG-93	93% O2 / 3% N2 / 4% Ar	205.62114	1.31687	0.9993670	191.795	1.4379	0.9990499
199	OCG-95	95% O2 / 1% N2 / 4% Ar	206.16497	1.32014	0.9993580	192.241	1.4414	0.99904

STACK GASES				25°C		0°C		
Gas Number	Short Name	Long Name	Absolute Viscosity*	Density** 14.696 PSIA	Compressibility 14.696 PSIA	Absolute Viscosity	Density 14.696 PSIA	Compressibility 14.696 PSIA
200	FG-1	2.5% O2 / 10.8% CO2 / 85.7% N2 / 1% Ar	175.22575	1.22550	0.9992625	165.222	1.3379	0.9990842
201	FG-2	2.9% O2 / 14% CO2 / 82.1% N2 / 1% Ar	174.18002	1.24729	0.9991056	164.501	1.3617	0.99899417
202	FG-3	3.7% O2 / 15% CO2 / 80.3% N2 / 1% Ar	174.02840	1.25520	0.9990536	164.426	1.3703	0.9988933
203	FG-4	7% O2 / 12% CO2 / 80% N2 / 1% Ar	175.95200	1.24078	0.9991842	166.012	1.3546	0.9990116
204	FG-5	10% O2 / 9.5% CO2 / 79.5% N2 / 1% Ar	177.65729	1.22918	0.9992919	167.401	1.3419	0.9991044
205	FG-6	13% O2 / 7% CO2 / 79% N2 / 1% Ar	179.39914	1.21759	0.9993996	168.799	1.3293	0.9991932

CHROMATOGRAPHY GASES				25°C		0°C		
Gas Number	Short Name	Long Name	Absolute Viscosity*	Density** 14.696 PSIA	Compressibility 14.696 PSIA	Absolute Viscosity	Density 14.696 PSIA	Compressibility 14.696 PSIA
29	P-5	5% CH4 / 95% Ar	223.91060	1.58505	0.9993265	207.988	1.7307	0.9990036
206	P-10	10% CH4 90% Ar	221.41810	1.53622	0.9992857	205.657	1.6774	0.99895

\*in micropoise (1 Poise = gram / (cm) (sec))      \*\*Grams/Liter      Reference: NIST REFPROP 9 Database

# Numerical List of Gases

Number	Short Name	Long Name
0	Air	Air
1	Ar	Argon
2	CH <sub>4</sub>	Methane
3	CO	Carbon Monoxide
4	CO <sub>2</sub>	Carbon Dioxide
5	C <sub>2</sub> H <sub>6</sub>	Ethane
6	H <sub>2</sub>	Hydrogen
7	He	Helium
8	N <sub>2</sub>	Nitrogen
9	N <sub>2</sub> O	Nitrous Oxide
10	Ne	Neon
11	O <sub>2</sub>	Oxygen
12	C <sub>3</sub> H <sub>8</sub>	Propane
13	n-C <sub>4</sub> H <sub>10</sub>	n-Butane
14	C <sub>2</sub> H <sub>2</sub>	Acetylene
15	C <sub>2</sub> H <sub>4</sub>	Ethylene (Ethene)
16	i-C <sub>4</sub> H <sub>10</sub>	i-Butane
17	Kr	Krypton
18	Xe	Xenon
19	SF <sub>6</sub>	Sulfur Hexafluoride
20	C-25	25% CO <sub>2</sub> / 75% Ar
21	C-10	10% CO <sub>2</sub> / 90% Ar
22	C-8	8% CO <sub>2</sub> / 92% Ar
23	C-2	2% CO <sub>2</sub> / 98% Ar
24	C-75	75% CO <sub>2</sub> / 25% Ar
25	He-25	25% He / 75% Ar
26	He-75	75% He / 25% Ar
27	A1025	90% He / 7.5% Ar / 2.5% CO <sub>2</sub>
28	Star29	Stargon CS 90% Ar / 8% CO <sub>2</sub> / 2% O <sub>2</sub>
29	P-5	5% CH <sub>4</sub> / 95% Ar
30	NO	NO (Nitric Oxide)
31	NF <sub>3</sub>	NF <sub>3</sub> (Nitrogen Trifluoride)
32	NH <sub>3</sub>	Ammonia
33	Cl <sub>2</sub>	Chlorine
34	H <sub>2</sub> S	Hydrogen Sulfide (H <sub>2</sub> S)
35	SO <sub>2</sub>	Sulfur Dioxide
36	C <sub>3</sub> H <sub>6</sub>	Propylene (Propylene)
60	D <sub>2</sub>	Deuterium
80	1Butene	Butylene (1-Butene)
81	cButene	Cis-Butene (cis-2-butene)
82	iButene	Iso-Butene
83	tButene	Trans-Butene
84	COS	Carbonyl Sulfide
85	CH <sub>3</sub> OCH <sub>3</sub>	Dimethylether
86	SiH <sub>4</sub>	Silane (SiH <sub>4</sub> )
140	C-15	15% CO <sub>2</sub> / 85% Ar
141	C-20	20% CO <sub>2</sub> / 80% Ar



<b>Number</b>	<b>Short Name</b>	<b>Long Name</b>
142	C-50	50% CO <sub>2</sub> / 50% Ar
143	He-50	50% He / 50% Ar
144	He-90	90% He / 10% Ar
145	Bio-5M	5% CH <sub>4</sub> / 95% CO <sub>2</sub>
146	Bio-10M	10% CH <sub>4</sub> / 90% CO <sub>2</sub>
147	Bio-15M	15% CH <sub>4</sub> / 85% CO <sub>2</sub>
148	Bio-20M	20% CH <sub>4</sub> / 80% CO <sub>2</sub>
149	Bio-25M	25% CH <sub>4</sub> / 75% CO <sub>2</sub>
150	Bio-30M	30% CH <sub>4</sub> / 70% CO <sub>2</sub>
151	Bio-35M	35% CH <sub>4</sub> / 65% CO <sub>2</sub>
152	Bio-40M	40% CH <sub>4</sub> / 60% CO <sub>2</sub>
153	Bio-45M	45% CH <sub>4</sub> / 55% CO <sub>2</sub>
154	Bio-50M	50% CH <sub>4</sub> / 50% CO <sub>2</sub>
155	Bio-55M	55% CH <sub>4</sub> / 45% CO <sub>2</sub>
156	Bio-60M	60% CH <sub>4</sub> / 40% CO <sub>2</sub>
157	Bio-65M	65% CH <sub>4</sub> / 35% CO <sub>2</sub>
158	Bio-70M	70% CH <sub>4</sub> / 30% CO <sub>2</sub>
159	Bio-75M	75% CH <sub>4</sub> / 25% CO <sub>2</sub>
160	Bio-80M	80% CH <sub>4</sub> / 20% CO <sub>2</sub>
161	Bio-85M	85% CH <sub>4</sub> / 15% CO <sub>2</sub>
162	Bio-90M	90% CH <sub>4</sub> / 10% CO <sub>2</sub>
163	Bio-95M	95% CH <sub>4</sub> / 5% CO <sub>2</sub>
164	EAN-32	32% O <sub>2</sub> / 68% N <sub>2</sub>
165	EAN	36% O <sub>2</sub> / 64% N <sub>2</sub>
166	EAN-40	40% O <sub>2</sub> / 60% N <sub>2</sub>
167	HeOx-20	20% O <sub>2</sub> / 80% He
168	HeOx-21	21% O <sub>2</sub> / 79% He
169	HeOx-30	30% O <sub>2</sub> / 70% He
170	HeOx-40	40% O <sub>2</sub> / 60% He
171	HeOx-50	50% O <sub>2</sub> / 50% He
172	HeOx-60	60% O <sub>2</sub> / 40% He
173	HeOx-80	80% O <sub>2</sub> / 20% He
174	HeOx-99	99% O <sub>2</sub> / 1% He
175	EA-40	Enriched Air-40% O <sub>2</sub>
176	EA-60	Enriched Air-60% O <sub>2</sub>
177	EA-80	Enriched Air-80% O <sub>2</sub>
178	Metabol	Metabolic Exhalant (16% O <sub>2</sub> / 78.04% N <sub>2</sub> / 5% CO <sub>2</sub> / 0.96% Ar)
179	LG-4.5	4.5% CO <sub>2</sub> / 13.5% N <sub>2</sub> / 82% He
180	LG-6	6% CO <sub>2</sub> / 14% N <sub>2</sub> / 80% He
181	LG-7	7% CO <sub>2</sub> / 14% N <sub>2</sub> / 79% He
182	LG-9	9% CO <sub>2</sub> / 15% N <sub>2</sub> / 76% He
183	HeNe-9	9% Ne / 91% He
184	LG-9.4	9.4% CO <sub>2</sub> / 19.25% N <sub>2</sub> / 71.35% He
185	Syn Gas-1	40% H <sub>2</sub> + 29% CO + 20% CO <sub>2</sub> + 11% CH <sub>4</sub>
186	Syn Gas-2	64% H <sub>2</sub> + 28% CO + 1% CO <sub>2</sub> + 7% CH <sub>4</sub>

Number	Short Name	Long Name
187	Syn Gas-3	70% H <sub>2</sub> + 4% CO + 25% CO <sub>2</sub> + 1% CH <sub>4</sub>
188	Syn Gas-4	83% H <sub>2</sub> + 14% CO + 3% CH <sub>4</sub>
189	Nat Gas-1	93% CH <sub>4</sub> / 3% C <sub>2</sub> H <sub>6</sub> / 1% C <sub>3</sub> H <sub>8</sub> / 2% N <sub>2</sub> / 1% CO <sub>2</sub>
190	Nat Gas-2	95% CH <sub>4</sub> / 3% C <sub>2</sub> H <sub>6</sub> / 1% N <sub>2</sub> / 1% CO <sub>2</sub>
191	Nat Gas-3	95.2% CH <sub>4</sub> / 2.5% C <sub>2</sub> H <sub>6</sub> / 0.2% C <sub>3</sub> H <sub>8</sub> / 0.1% C <sub>4</sub> H <sub>10</sub> / 1.3% N <sub>2</sub> / 0.7% CO <sub>2</sub>
192	Coal Gas	50% H <sub>2</sub> / 35% CH <sub>4</sub> / 10% CO / 5% C <sub>2</sub> H <sub>4</sub>
193	Endo	75% H <sub>2</sub> + 25% N <sub>2</sub>
194	HHO	66.67% H <sub>2</sub> / 33.33% O <sub>2</sub>
195	HD-5	LPG 96.1% C <sub>3</sub> H <sub>8</sub> / 1.5% C <sub>2</sub> H <sub>6</sub> / 0.4% C <sub>3</sub> H <sub>6</sub> / 1.9% n-C <sub>4</sub> H <sub>10</sub>
196	HD-10	LPG 85% C <sub>3</sub> H <sub>8</sub> / 10% C <sub>3</sub> H <sub>6</sub> / 5% n-C <sub>4</sub> H <sub>10</sub>
197	OCG-89	89% O <sub>2</sub> / 7% N <sub>2</sub> / 4% Ar
198	OCG-93	93% O <sub>2</sub> / 3% N <sub>2</sub> / 4% Ar
199	OCG-95	95% O <sub>2</sub> / 1% N <sub>2</sub> / 4% Ar
200	FG-1	2.5% O <sub>2</sub> / 10.8% CO <sub>2</sub> / 85.7% N <sub>2</sub> / 1% Ar
201	FG-2	2.9% O <sub>2</sub> / 14% CO <sub>2</sub> / 82.1% N <sub>2</sub> / 1% Ar
202	FG-3	3.7% O <sub>2</sub> / 15% CO <sub>2</sub> / 80.3% N <sub>2</sub> / 1% Ar
203	FG-4	7% O <sub>2</sub> / 12% CO <sub>2</sub> / 80% N <sub>2</sub> / 1% Ar
204	FG-5	10% O <sub>2</sub> / 9.5% CO <sub>2</sub> / 79.5% N <sub>2</sub> / 1% Ar
205	FG-6	13% O <sub>2</sub> / 7% CO <sub>2</sub> / 79% N <sub>2</sub> / 1% Ar
206	P-10	10% CH <sub>4</sub> 90% Ar

# Device Units

Your device can display data in various engineering units. The most current listing of engineering units is available at [alicat.com/units](http://alicat.com/units). You can change units from the Main Display (page 18) or from the Basic Configuration menu (page 22). Only the units appropriate to your flow meter are available for selection.

## Flow Units

Volumetric	Standard	Normal	Notes
uL/m	SuL/m	NuL/m	microliter per minute
mL/s	SmL/s	NmL/s	milliliter per second
mL/m	SmL/m	NmL/m	milliliter per minute
mL/h	Sml/h	NmL/h	milliliter per hour
L/s	SL/s	NL/s	liter per second
LPM	SLPM	NLPM	liter per minute
L/h	SL/h	NL/h	liter per hour
US GPM			US gallon per minute
US GPH			US gallon per hour
CCS	SCCS	NCCS	cubic centimeter per second
CCM	SCCM	NCCM	cubic centimeter per minute
cm <sup>3</sup> /h	Scm <sup>3</sup> /h	Ncm <sup>3</sup> /h	cubic centimeter per hour
m <sup>3</sup> /m	Sm <sup>3</sup> /m	Nm <sup>3</sup> /m	cubic meter per minute
m <sup>3</sup> /h	Sm <sup>3</sup> /h	Nm <sup>3</sup> /h	cubic meter per hour
m <sup>3</sup> /d	Sm <sup>3</sup> /d	Nm <sup>3</sup> /d	cubic meter per day
in <sup>3</sup> /m	Sin <sup>3</sup> /m		cubic inch per minute
CFM	SCFM		cubic foot per minute
CFH	SCFH		cubic foot per hour
CFD	SCFD		cubic foot per day
	kSCFM		1000 cubic feet per minute
count	count	count	setpoint count, 0 – 64000
%	%	%	percent of full scale

## True Mass Flow Units

Label	Notes
mg/s	milligram per second
mg/m	milligram per minute
g/s	gram per second
g/m	gram per minute
g/h	gram per hour
kg/m	kilogram per minute
kg/h	kilogram per hour
oz/s	ounce per second
oz/m	ounce per minute
lb/m	pound per minute
lb/h	pound per hour

# Device Units

## Pressure Units

Absolute/Barometric	Gauge	Notes
PaA	PaG	pascal
hPaA	hPaG	hectopascal
kPaA	kPaG	kilopascal
MPaA	MPaG	megapascal
mbarA	mbarG	millibar
barA	barG	bar
g/cm2A	g/cm2G	gram force per square centimeter
kg/cmA	kg/cmG	kilogram force per square centimeter
PSIA	PSIG	pound force per square inch
PSFA	PSFG	pound force per square foot
mTorrA	mTorrG	millitorr
torrA	torrG	torr
mmHgA	mmHgG	millimeter of mercury at 0 C
inHgA	inHgG	inch of mercury at 0 C
mmH2OA	mmH2OG	millimeter of water at 4 C (NIST conventional)
mmH2OA	mmH2OG	millimeter of water at 60 C
cmH2OA	cmH2OG	centimeter of water at 4 C (NIST conventional)
cmH2OA	cmH2OG	centimeter of water at 60 C
inH2OA	inH2OG	inch of water at 4 C (NIST conventional)
inH2OA	inH2OG	inch of water at 60 C
atm		atmosphere
m asl		meter above sea level (only in /ALT builds)
ft asl		foot above sea level (only in /ALT builds)
V		volt; no conversions are performed to or from other units
count	count	setpoint count, 0 – 64000
%	%	percent of full scale

## Temperature Units

Label	Notes
°C	degree Celsius
°F	degree Fahrenheit
K	Kelvin
°R	degree Rankine

## Time Units

Label	Notes
h:m:s	Displayed value is hours:minutes:seconds
ms	millisecond
s	second
m	minute
hour	hour
day	day

# Accessories

Part Number	Description
FLOWVISIONSC	Flow Vision™ SC software for interface with all Alicat instruments
FLOWVISIONMX	Flow Vision™ MX software for gas blending
BB9-232	9 position Multi Drop Box with 9-pin serial port and USB to PC
BB9-I	9 position Multi-Drop Box, Industrial connectors
PVPS24U	Universal 100-240 VAC to 24 Volt DC Power Supply Adapter
PS24VHC	High current power supply for BB9 use with Large Valve Controllers
PVPS5USB	micro-USB to wall adapter
PCASE	Industrial carry and storage case for up to 2 portable meters/gauges
PCASE-L	Industrial carry and storage case for up to 6 meters and controllers
DC-61	8 Pin Male Mini-DIN connector cable, single ended, 6 foot length
DC-6RT	8 Pin Male Right Angle Mini-DIN Cable, single ended, 6 foot length
DC-251	8 Pin Male Mini-DIN connector cable, single ended, 25 foot length
DC-501	8 Pin Male Mini-DIN connector cable, single ended, 50 foot length
DC-751	8 Pin Male Mini-DIN connector cable, single ended, 75 foot length
DC-1001	8 Pin Male Mini-DIN connector cable, single ended, 100 foot length
DC-32RS	8-pin Male Mini-DIN connector cable, double ended, no analog, 3 foot length
DC-62RS	8-pin Male Mini-DIN connector cable, double ended, no analog, 6 foot length
DC-62	8 Pin Male Mini-DIN connector cable, double ended, 6 foot length
DC-252	8 Pin Male Mini-DIN connector cable, double ended, 25 foot length
DC-502	8 Pin Male Mini-DIN connector cable, double ended, 50 foot length
MD8DB9	8 Pin Male Mini-DIN to DB9 Female Adapter, 6 foot length
DBC-251	DB15 cable, single ended, 25 foot length
510199	DB9 cable, double-ended female, 3 meter length
IC10	Industrial cable, 6 Pin, single ended, 10 foot length
IC20	Industrial cable, 6 Pin, single ended, 20 foot length
IC50	Industrial cable, 6 Pin, single ended, 50 foot length
IC-102	Industrial cable, 6 pin double ended, 10 foot length

# Accessories

MNPT to Compression Fittings	
10-32 - 1/8"	SS-200-1-0157
10-32 - 1/4"	SS-400-1-0256
1/8" - 1/8"	SS-200-1-2
1/8" - 1/4"	SS-400-1-2
1/8" - 3/8"	SS-600-1-2
1/8" - 1/2"	SS-810-1-2
1/8" - 3mm	SS-3M0-1-2
1/8" - 4mm	SS-4M0-1-2
1/8" - 6mm	SS-6M0-1-2
1/8" - 8mm	SS-8M0-1-2
1/8" - 12mm	SS-12M0-1-2
1/4" - 1/8"	SS-200-1-4
1/4" - 1/4"	SS-400-1-4
1/4" - 3/8"	SS-600-1-4
1/4" - 1/2"	SS-810-1-4
1/4" - 3mm	SS-3M0-1-4
1/4" - 4mm	SS-4M0-1-4
1/4" - 6mm	SS-6M0-1-4
1/4" - 8mm	SS-8M0-1-4
1/4" - 12mm	SS-12M0-1-4
1/2" - 1/8"	SS-200-1-8
1/2" - 1/4"	SS-400-1-8
1/2" - 3/8"	SS-600-1-8
1/2" - 1/2"	SS-810-1-8
1/2" - 3/4"	SS-1210-1-8
1/2" - 6mm	SS-6M0-1-8
1/2" - 8mm	SS-8M0-1-8
1/2" - 12mm	SS-12M0-1-8
1/2" - 16mm	SS-16M0-1-8
3/4" - 1/4"	SS-400-1-12
3/4" - 1/2"	SS-810-1-12
3/4" - 3/4"	SS-1210-1-12
3/4" - 12mm	SS-12M0-1-12
3/4" - 16mm	SS-16M0-1-12

Filters & Elements FNPT-MNPT	
0-32 5μ	510053
10-32 20μ	510054
1/8" 20μ	ILF-1/8-20
1/4" 40μ	ILF-1/4-40
1/2" 40μ	ILF-1/2-40*
3/4" 40μ	ILF-3/4-40*
20μ element	ILFE20
40μ element	ILFE40
40μ element	ILFE40L*

Filters & Elements FNPT-FNPT*	
0-32 5μ	CF-303-20-316
*requires MNPT to MNPT coupler to interface with Alicat flow bodies	

10-32 Male UNF to 1/8 FNPT Adapter	
410133	
Male M5 (10-32) Buna-N O-ring face seal to 1/8" Female NPT	

# Specification Sheets

## Technical Data for Alicat M Mass Flow Meters

0 to 0.5 sccm Full Scale through 0 to 5000 slpm Full Scale

### Standard Operating Specifications (Contact Alicat for available options)

Performance	M-Series Mass Flow Meter
Accuracy at calibration conditions after tare	± (0.8% of Reading + 0.2% of Full Scale)
High Accuracy at calibration conditions after tare	± (0.4% of Reading + 0.2% of Full Scale) High Accuracy option not available for units ranged under 5 sccm or over 500 slpm.
Accuracy for Bidirectional Meters at calibration conditions after tare	± (0.8% of reading + 0.2% of total span from positive full scale to negative full scale)
Repeatability	± 0.2% Full Scale
Zero Shift and Span Shift	0.02% Full Scale / °Celsius / Atm
Operating Range / Turndown Ratio	0.5% to 100% Full Scale / 200:1 Turndown
Maximum Measurable Flow Rate	up to 128% Full Scale (Gas Dependent)
Typical Response Time	10 ms (Adjustable)
Warm-up Time	< 1 Second

Operating Conditions	M-Series Mass Flow Meter
Mass Reference Conditions (STP)	25°C & 14.696 psia (standard — others available on request)
Operating Temperature	-10 to +60 °Celsius
Humidity Range (Non-Condensing)	0 to 100%
Maximum Internal Pressure (Static)	145 psig
Maximum Allowable Instantaneous Differential Pressure Across Device (Inlet to Outlet)	75 psid
Proof Pressure	175 psig
Mounting Attitude Sensitivity	None
Ingress Protection	IP40
Wetted Materials	303 & 302 Stainless Steel, Viton®, Heat Cured Silicone Rubber, Glass Reinforced Polyphenylene Sulfide, Heat Cured Epoxy, Aluminum, Gold, Silicon, Glass. If your application demands a different material, please contact Alicat.

Communications / Power	M-Series Mass Flow Meter
Monochrome LCD or Color TFT Display with integrated touchpad	Simultaneously displays Mass Flow, Volumetric Flow, Pressure and Temperature
Digital Communications Options <sup>1</sup>	RS-232 Serial, RS-485 Serial, DeviceNet, EtherCAT, EtherNet/IP, Modbus RTU, Modbus TCP/IP, PROFIBUS
Analog Signal <sup>2</sup> Options	0-5 Vdc / 1-5 Vdc / 0-10 Vdc / 4-20 mA
Optional Secondary Analog Output Signal <sup>2</sup>	0-5 Vdc / 1-5 Vdc / 0-10 Vdc / 4-20 mA
Electrical Connection Options	8 pin Mini-DIN, 9 pin D-sub (DB9), 15 pin D-sub (DB15), 6 pin locking, 8 pin M12
Supply Voltage	7 to 30 Vdc (15-30 Vdc for 4-20 mA outputs)
Supply Current	0.040 Amp (+ output current on 4-20 mA)

1. The **Digital Output Signal** communicates Mass Flow, Volumetric Flow, Pressure and Temperature

2. The **Analog Output Signal** and **Optional Secondary Analog Output Signal** communicate your choice of Mass Flow, Volumetric Flow, Pressure or Temperature

### Range Specific Specifications

Full Scale Flow Mass Meter	Pressure Drop at FS Flow (psid) venting to atmosphere <sup>1</sup>	Mechanical Dimensions	Process Connections <sup>2</sup>
0.5 sccm to 1 sccm	1.0		
2 sccm to 50 sccm	1.0	3.9"H x 2.4"W x 1.1"D	M-5 (10-32) Female Thread <sup>3</sup>
100 sccm to 20 slpm	1.0	4.1"H x 2.4"W x 1.1"D	1/8" NPT Female
50 slpm	2.0		
100 slpm	2.5	4.4"H x 4.0"W x 1.6"D	1/4" NPT Female
250 slpm	2.1	5.0"H x 4.0"W x 1.6"D	1/2" NPT Female
500 slpm	4.0		
1000 slpm	6.0	5.0"H x 4.0"W x 1.6"D	3/4" NPT Female
1500 slpm	9.0		
2000 slpm	5.0	5.3"H x 5.2"W x 2.9"D	(A 1-1/4" NPT Female optional process connection is available for 2000 slpm meters.)
3000 slpm	7.1	5.3"H x 5.2"W x 2.9"D	1-1/4" NPT Female
5000 slpm	3.4	6.3"H x 5.2"W x 3.9"D	2" NPT Female

1. Lower Pressure Drops Available, please see our **WHISPER-Series** mass flow controllers at [www.alicat.com/whisper](http://www.alicat.com/whisper).

2. Compatible with Swagelok® tube, Parker®, face seal, push connect and compression adapter fittings. VCR and SAE connections upon request.

3. Shipped with M-5 (10-32) Male Buna-N O-ring face seal to 1/8" Female NPT fittings.

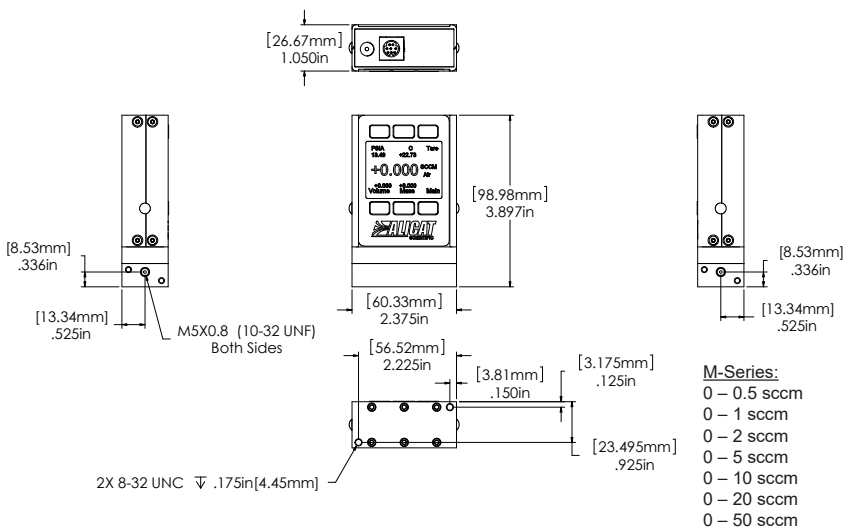

0.5 sccm to 50 sccm approximate shipping weight: 0.8 lb

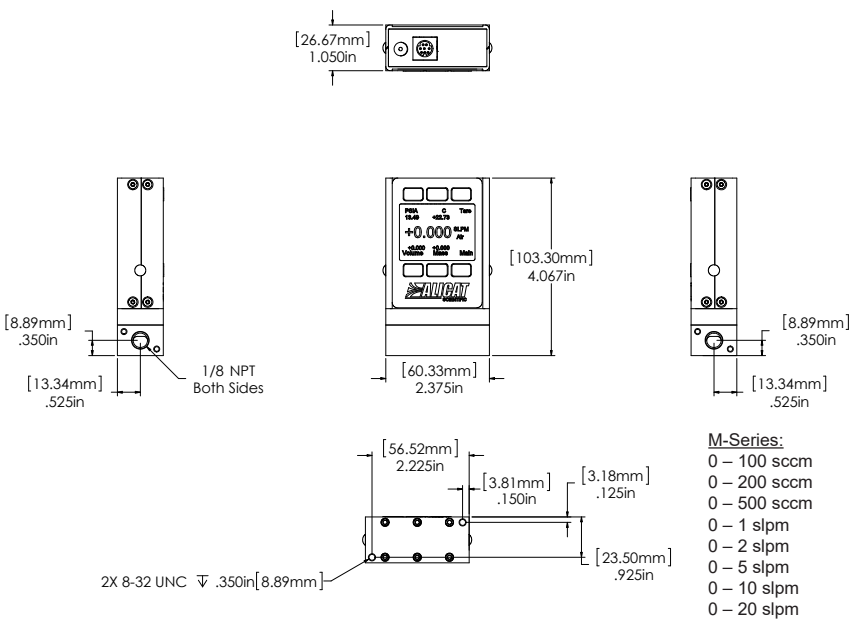

100 sccm to 20 slpm approximate shipping weight: 1.0 lb



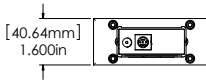

M-Series:  
0 – 50 slpm  
0 – 100 slpm

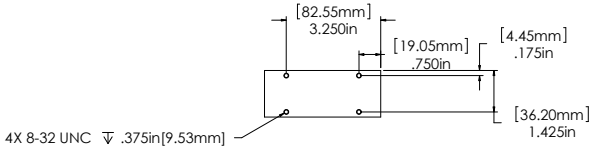
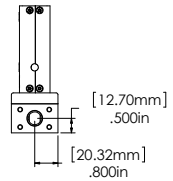
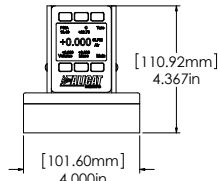
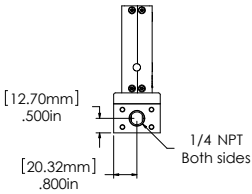

50 slpm to 100 slpm approximate shipping weight: 2.4 lb.

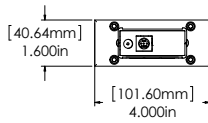

M-Series:  
0 – 250 slpm

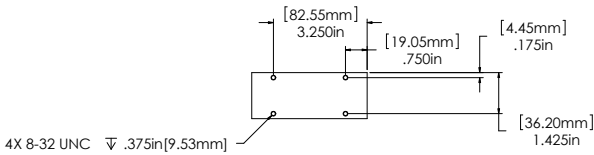
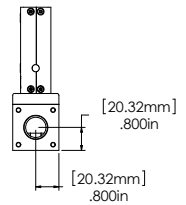
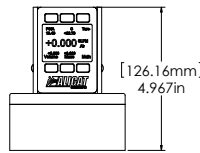
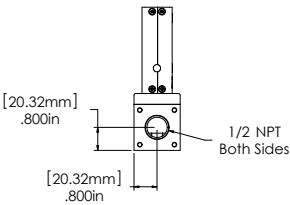

250 slpm approximate shipping weight: 3.2 lb.

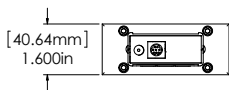

**M-Series:**

- 0 – 500 slpm
- 0 – 1000 slpm
- 0 – 1500 slpm

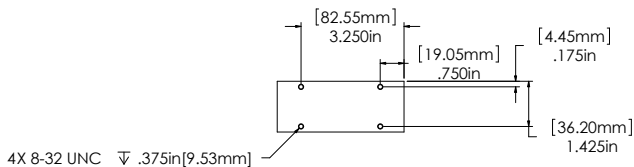
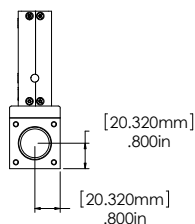
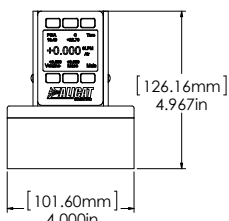
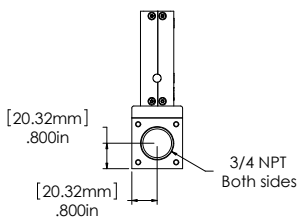

500 slpm to 1500 slpm approximate shipping weight: 3.5 lb

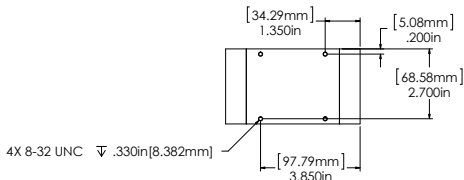
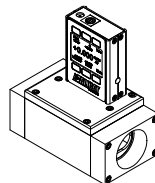
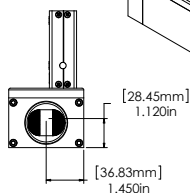
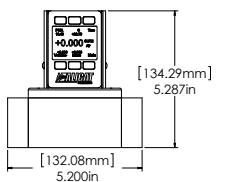
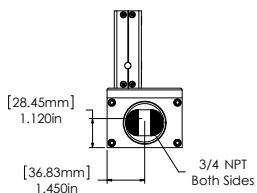
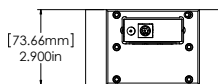

**M-Series:**

- 0 – 2000 slpm

2000 slpm approximate shipping weight: 4.5 lb

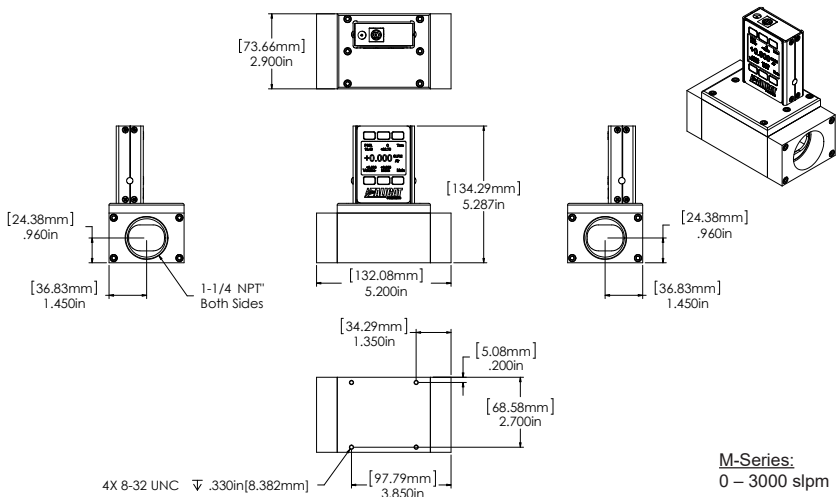

3000 slpm approximate shipping weight: 4.5 lb

**M-Series:**  
0 – 4000 slpm

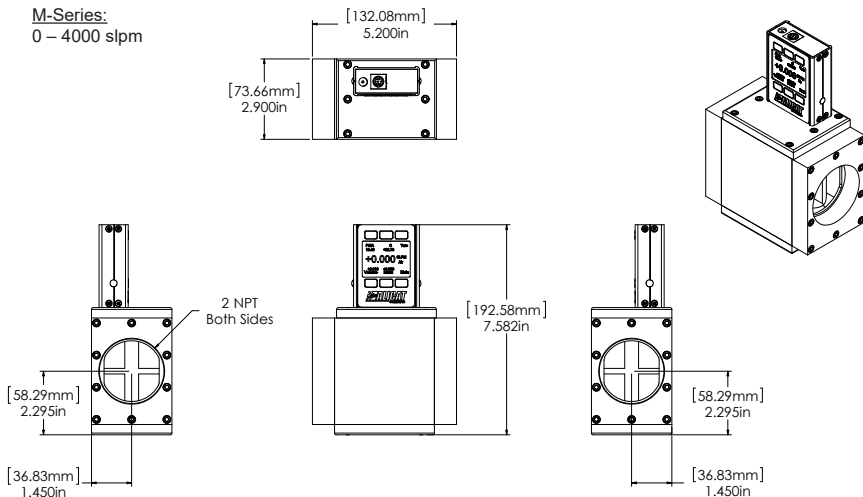

4000 slpm approximate shipping weight: 12.2 lb

**M-Series:**  
**0 – 5000 slpm**

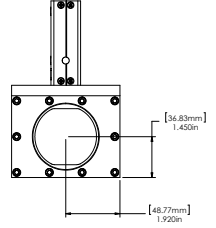
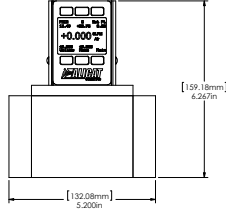
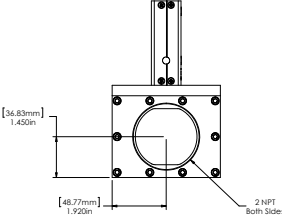
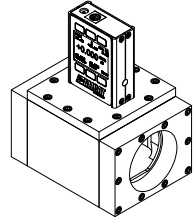
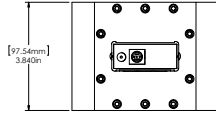

5000 slpm approximate shipping weight: 14 lb

# Technical Data for WHISPER Low Pressure Drop Mass Flow Meters

## 0 to 0.5 sccm Full Scale through 0 to 1000 slpm Full Scale

### Standard Operating Specifications (Contact Alicat for available options.)

Performance	Whisper Mass Flow Meter
Accuracy at calibration conditions after tare	± (0.8% of Reading + 0.2% of Full Scale)
High Accuracy at calibration conditions after tare	± (0.4% of Reading + 0.2% of Full Scale) High Accuracy option not available for units ranged under 5 sccm or over 500 slpm.
Accuracy for Bidirectional Meters at calibration conditions after tare	± (0.8% of reading + 0.2% of total span from positive full scale to negative full scale)
Repeatability	± 0.2% Full Scale
Zero Shift and Span Shift	0.02% Full Scale / °Celsius / Atm
Operating Range / Turndown Ratio	0.5% to 100% Full Scale / 200:1 Turndown
Maximum Measurable Flow Rate	up to 128% Full Scale (Gas Dependent)
Typical Response Time	10 ms (Adjustable)
Warm-up Time	< 1 Second

Operating Conditions	Whisper Mass Flow Meter
Mass Reference Conditions (STP)	25°C & 14.696 psia (standard — others available on request)
Operating Temperature	-10 to +60 °Celsius
Humidity Range (Non-Condensing)	0 to 100%
Maximum Pressure	45 psig
Maximum Allowable Instantaneous Differential Pressure Across Device (Inlet to Outlet)	15 psid
Proof Pressure	175 psig
Mounting Attitude Sensitivity	None
Ingress Protection	IP40
Wetted Materials	303 & 302 Stainless Steel, Viton®, Heat Cured Silicone Rubber, Glass Reinforced Polyphenylene Sulfide, Heat Cured Epoxy, Aluminum, Gold, Silicon, Glass. If your application demands a different material, please contact Alicat.

Communications / Power	Whisper Mass Flow Meter
Monochrome LCD or Color TFT Display with integrated touchpad	Simultaneously displays Mass Flow, Volumetric Flow, Pressure and Temperature
Digital Communications Options <sup>1</sup>	RS-232 Serial, RS-485 Serial, DeviceNet, EtherCAT, EtherNet/IP, Modbus RTU, Modbus TCP/IP, PROFIBUS
Analog Signal <sup>2</sup> Options	0-5 Vdc / 1-5 Vdc / 0-10 Vdc / 4-20 mA
Optional Secondary Analog Output Signal <sup>2</sup>	0-5 Vdc / 1-5 Vdc / 0-10 Vdc / 4-20 mA
Electrical Connection Options	8 Pin Mini-DIN / 9-pin D-sub (DB9) / 15-pin D-sub (DB15) / 6 pin locking / 8pin M12
Supply Voltage	7 to 30 Vdc (15-30 Vdc for 4-20 mA outputs)
Supply Current	0.040 Amp (+ output current on 4-20 mA)
<ol style="list-style-type: none"> <li>The <b>Digital Output Signal</b> communicates Mass Flow, Volumetric Flow, Pressure and Temperature</li> <li>The <b>Analog Output Signal</b> and <b>Optional Secondary Analog Output Signal</b> communicate your choice of Mass Flow, Volumetric Flow, Pressure or Temperature</li> </ol>	

### Range Specific Specifications

Full Scale Flow Mass Meter	Pressure Drop at FS Flow (psid) venting to atmosphere	Mechanical Dimensions	Process Connections <sup>1</sup>
0.5 sccm to 2 sccm	0.06	3.9"H x 2.4"W x 1.1"D	<b>M-5 (10-32) Female Thread<sup>2</sup></b>
5 sccm to 20 sccm	0.07		
50 sccm	0.07		
100 sccm to 200 sccm	0.06	4.1"H x 2.4"W x 1.1"D	1/8" NPT Female
500 sccm	0.07		
1 slpm to 5 slpm	0.07		
10 slpm	0.08	4.3"H x 2.7"W x 1.1"D	1/4" NPT Female
20 slpm	0.25	4.4"H x 4.0"W x 1.6"D	
40 slpm	0.12	5.0"H x 4.0"W x 1.6"D	
50 slpm	0.14	5.0"H x 4.0"W x 1.6"D	3/4" NPT Female
100 slpm	0.24		
250 slpm	0.60		
500 slpm	0.39	5.3"H x 5.2"W x 2.9"D	3/4" NPT Female
1000 slpm	0.24	6.3"H x 5.2"W x 3.9"D	2" NPT Female
<ol style="list-style-type: none"> <li>Compatible with Swagelok® tube, Parker®, face seal, push connect and compression adapter fittings. VCR and SAE connections upon request.</li> <li>Shipped with M-5 (10-32) Male Buna-N O-ring face seal to 1/8" Female NPT fittings.</li> </ol>			

**WHISPER MW:**

- 0 – 0.5 sccm
- 0 – 1 sccm
- 0 – 2 sccm
- 0 – 5 sccm
- 0 – 10 sccm
- 0 – 20 sccm

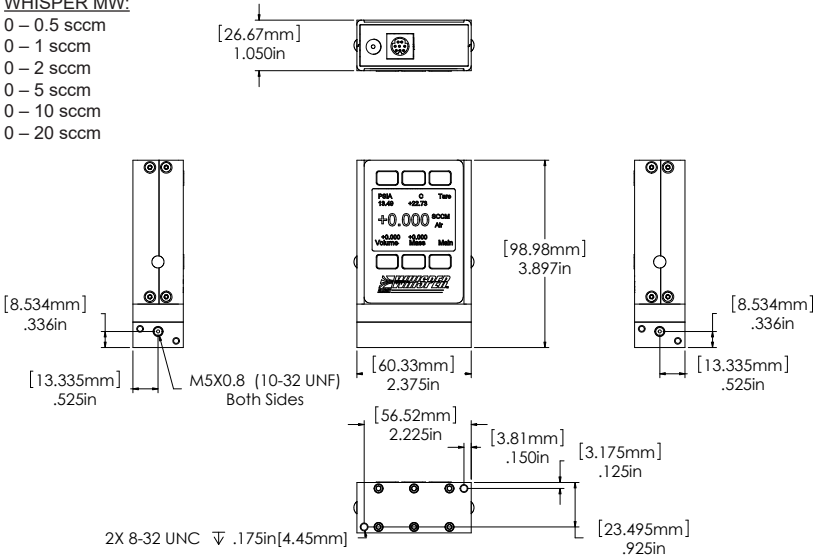

MW 0.5 sccm to 20 sccm approximate shipping weight: 0.8lb

**WHISPER MW:**

- 0 – 50 sccm
- 0 – 100 sccm
- 0 – 200 sccm
- 0 – 500 sccm
- 0 – 1 slpm
- 0 – 2 slpm
- 0 – 5 slpm

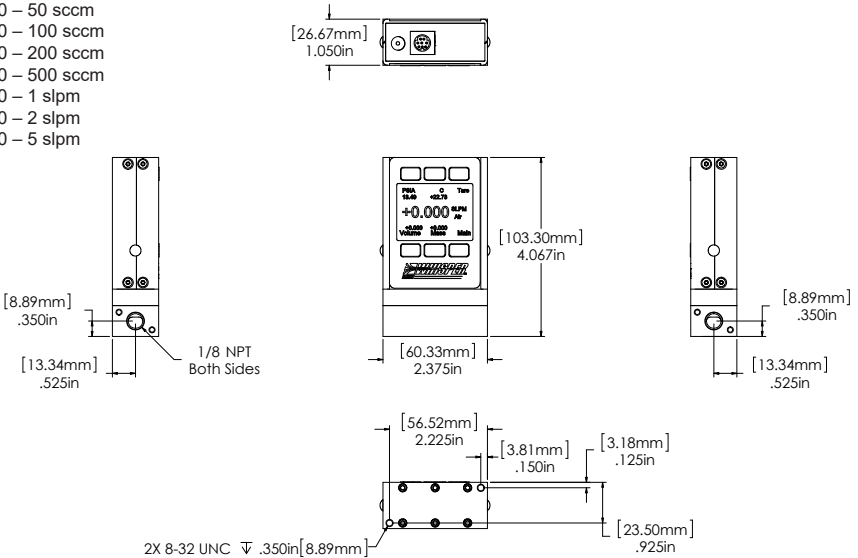

MW 50 sccm to 5 slpm approximate shipping weight: 1.0lb

**WHISPER MW:**  
0 – 10 slpm

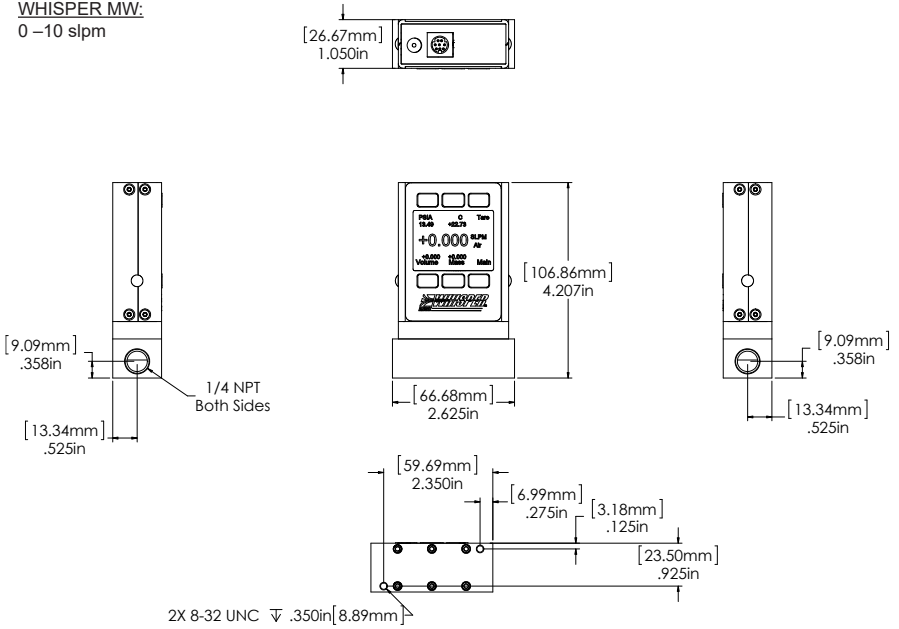

MW 10 slpm approximate shipping weight: 1.4 lb.

**WHISPER MW:**  
0 – 20 slpm

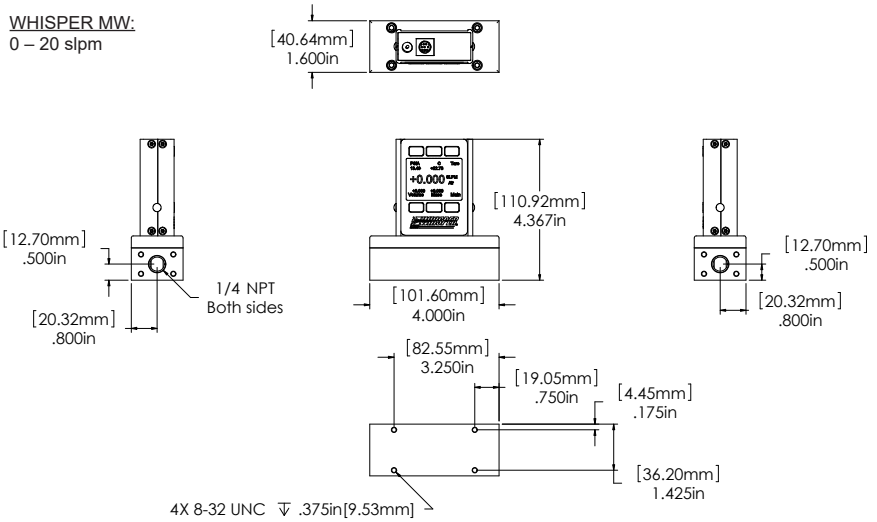

MW 20 slpm approximate shipping weight: 2.4 lb.

**WHISPER MW:**

0 – 40 slpm

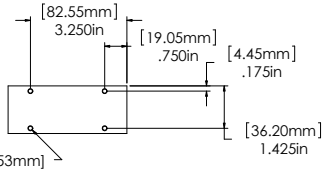
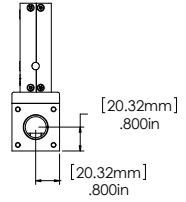
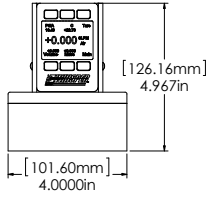
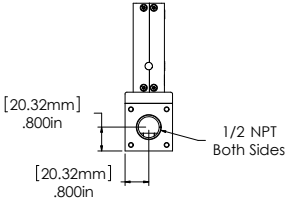
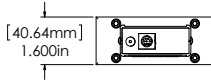

MW 40 slpm to 250 slpm approximate shipping weight: 3.5 lb.

**WHISPER MW**

0 – 50 slpm

0 – 100 slpm

0 – 250 slpm

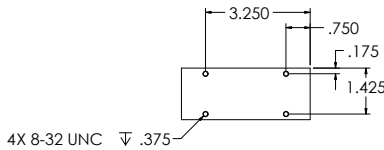
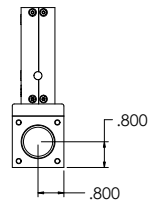
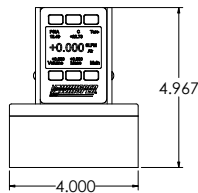
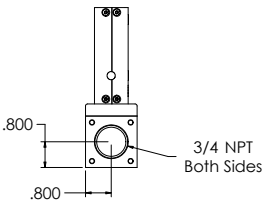
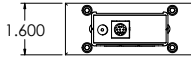

MW 50 slpm to 250 slpm approximate shipping weight: 3.2 lb.



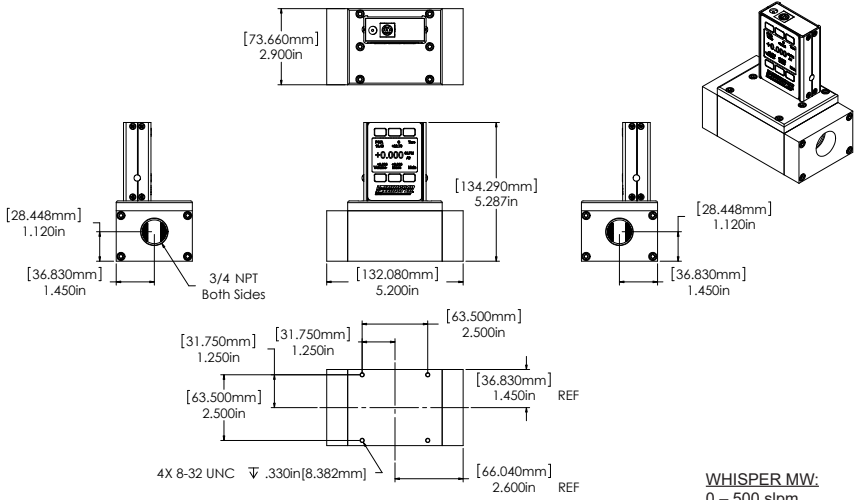

MW 500 slpm approximate shipping weight: 4.5lb

**WHISPER MW**  
0 – 1000 slpm

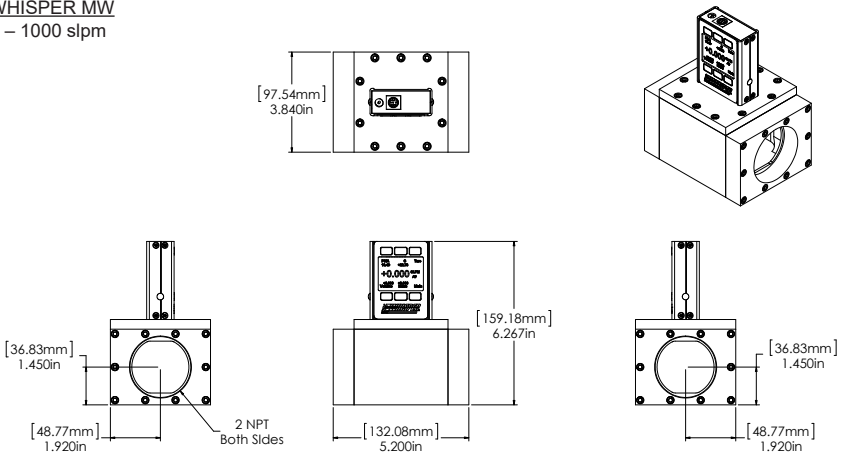

MW 1000 slpm approximate shipping weight: 7.0lb

# Technical Data for Alicat MS Mass Flow Meters

## 0 – 0.5 sccm Full Scale through 0 – 5000 slpm Full Scale

Alicat MS instruments are built for use with certain aggressive gases.

Performance	MS Mass Flow Meter
Accuracy at calibration conditions after tare	± (0.8% of Reading + 0.2% of Full Scale)
High Accuracy at calibration conditions after tare	± (0.4% of Reading + 0.2% of Full Scale) High Accuracy option not available for units ranged under 5 sccm or over 500 slpm.
Accuracy for Bidirectional Meters at calibration conditions after tare	± (0.8% of reading + 0.2% of total span from positive full scale to negative full scale)
Repeatability	± 0.2% Full Scale
Zero Shift and Span Shift	0.02% Full Scale / °Celsius / Atm
Operating Range / Turndown Ratio	1% to 100% Full Scale / 100:1 Turndown
Maximum Measurable Flow Rate	up to 128% Full Scale (Gas Dependent)
Typical Response Time	10 ms (Adjustable)
Warm-up Time	< 1 Second

Operating Conditions	MS Mass Flow Meter
Mass Reference Conditions (STP)	25°C & 14.696 psia (standard — others available on request)
Operating Temperature	-10 to +60 °Celsius
Humidity Range (Non-Condensing)	0 to 100%
Maximum Internal Pressure (Static)	145 psig
Maximum Allowable Instantaneous Differential Pressure Across Device (Inlet to Outlet)	75 psid
Proof Pressure	175 psig
Mounting Attitude Sensitivity	None
Ingress Protection	IP40
Wetted Materials	316LSS, FFKM (Kalrez) standard; Viton, EPDM, Buna, Neoprene as needed for some gases. If your application demands a different material, please contact Alicat.

Communications / Power	MS Mass Flow Meter
Monochrome LCD or Color TFT Display with integrated touchpad	Simultaneously displays Mass Flow, Volumetric Flow, Pressure and Temperature
Digital Communications Options <sup>1</sup>	RS-232 Serial, RS-485 Serial, DeviceNet, EtherCAT, EtherNet/IP, Modbus RTU, Modbus TCP/IP, PROFIBUS
Analog Signal <sup>2</sup> Options	0-5 Vdc / 1-5 Vdc / 0-10 Vdc / 4-20 mA
Optional Secondary Analog Output Signal <sup>2</sup>	0-5 Vdc / 1-5 Vdc / 0-10 Vdc / 4-20 mA
Electrical Connection Options	8 Pin Mini-DIN / 9-pin D-sub (DB9) / 15-pin D-sub (DB15) / 6 pin locking / 8pin M12
Supply Voltage	7 to 30 Vdc (15-30 Vdc for 4-20 mA outputs)
Supply Current	0.040 Amp (+ output current on 4-20 mA)
<p>1. The <b>Digital Output Signal</b> communicates Mass Flow, Volumetric Flow, Pressure and Temperature</p> <p>2. The <b>Analog Output Signal</b> and <b>Optional Secondary Analog Output Signal</b> communicate your choice of Mass Flow, Volumetric Flow, Pressure or Temperature</p>	

### Range Specific Specifications

Full Scale Flow Mass Meter	Pressure Drop at FS Flow (psid) venting to atmosphere <sup>1</sup>	Mechanical Dimensions	Process Connections <sup>2</sup>
0.5 sccm to 1 sccm	1.0	4.4"H x 2.4"W x 1.1"D	M-5 (10-32) Female Thread <sup>3</sup>
2 sccm to 50 sccm	1.0		
100 sccm to 20 slpm	1.0	4.6"H x 2.4"W x 1.1"D	1/8" NPT Female
50 slpm	2.0	5.1"H x 4.0"W x 1.6"D	1/4" NPT Female
100 slpm	2.5		
250 slpm	2.1	5.7"H x 4.0"W x 1.6"D	1/2" NPT Female
500 slpm	4.0	5.7"H x 4.0"W x 1.6"D	3/4" NPT Female (A 1-1/4" NPT Female optional process connection is available for 2000 slpm meters.)
1000 slpm	6.0		
1500 slpm	9.0		
2000 slpm	5.0		
3000 slpm	7.1	6.0"H x 5.2"W x 2.9"D	1-1/4" NPT Female
5000 slpm	3.4	7.0"H x 5.2"W x 3.9"D	2" NPT Female

1. Lower Pressure Drops Available, please see our **WHISPER-Series** mass flow controllers at [www.alicat.com/whisper](http://www.alicat.com/whisper).

2. Compatible with Swagelok® tube, Parker®, face seal, push connect and compression adapter fittings. VCR and SAE connections upon request.

3. Shipped with M-5 (10-32) Male Buna-N O-ring face seal to 1/8" Female NPT fittings.

**MS-Series:**

- 0 – 0.5 sccm
- 0 – 1 sccm
- 0 – 2 sccm
- 0 – 5 sccm
- 0 – 10 sccm
- 0 – 20 sccm
- 0 – 50 sccm

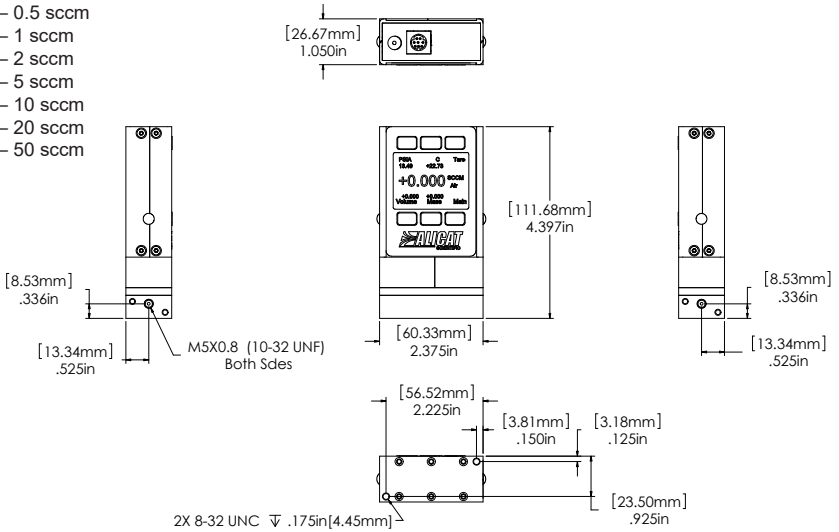

0.5 sccm to 50 sccm approximate shipping weight: 0.8lb

**MS-Series:**

- 0 – 100 sccm
- 0 – 200 sccm
- 0 – 500 sccm
- 0 – 1 slpm
- 0 – 2 slpm
- 0 – 5 slpm
- 0 – 10 slpm
- 0 – 20 slpm

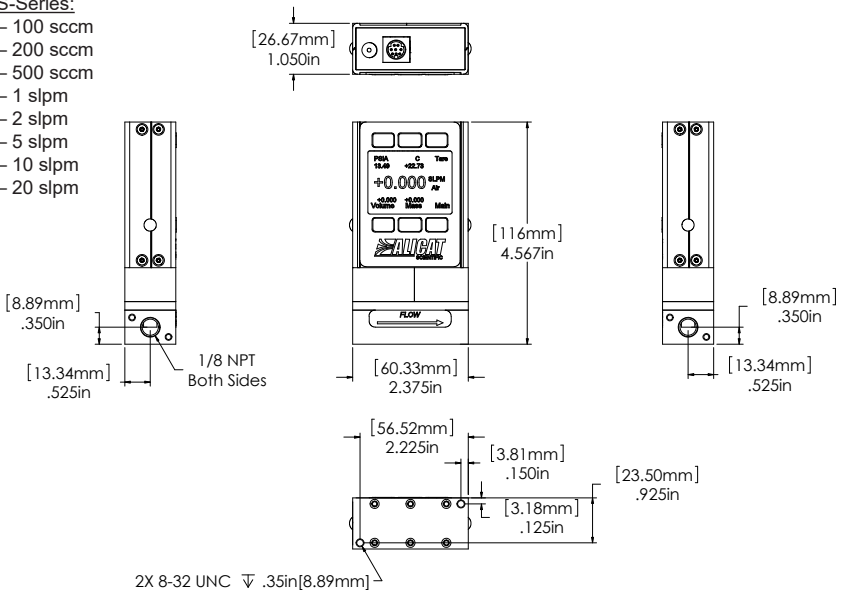

100 sccm to 20 slpm approximate shipping weight: 1.0 lb

**MS-Series:**

0 – 50 slpm

0 – 100 slpm

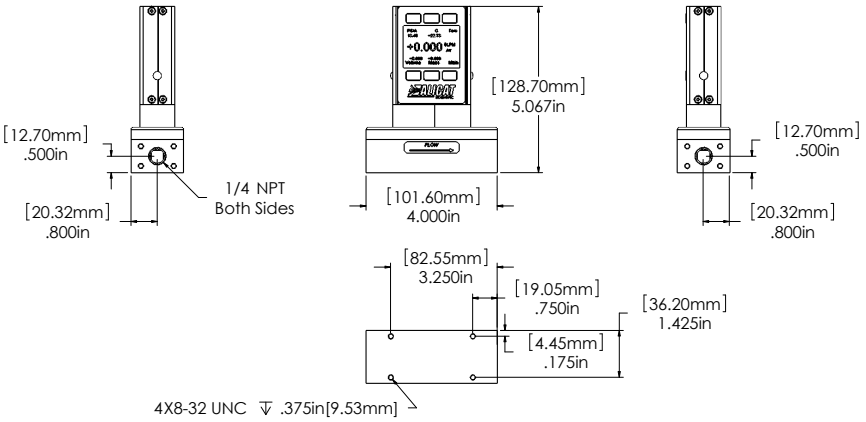
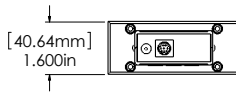

50 slpm to 100 slpm approximate shipping weight: 2.4 lb.

**MS-Series:**

0 – 250 slpm

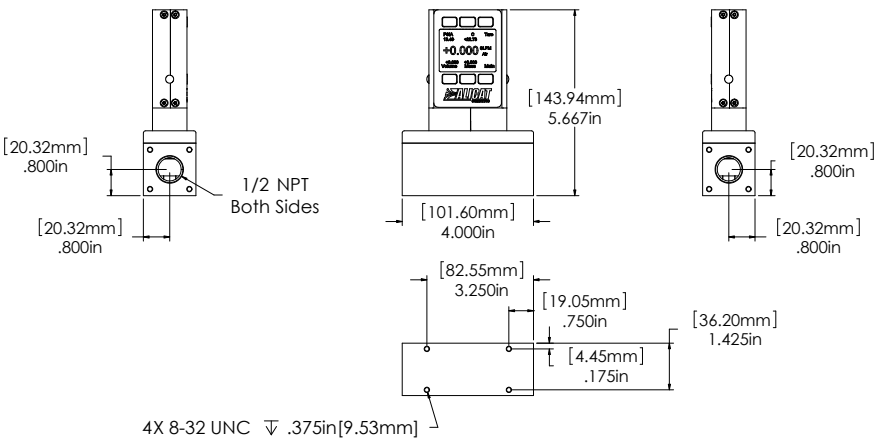
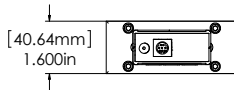

250 slpm approximate shipping weight: 3.2 lb.

**MS-Series:**

0 – 500 slpm  
 0 – 1000 slpm  
 0 – 1500 slpm

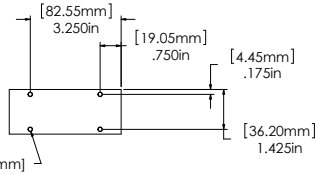
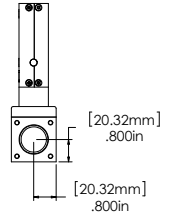
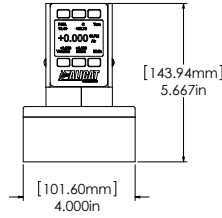
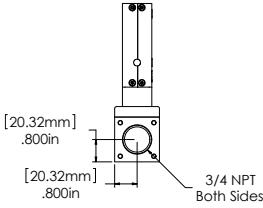
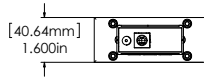

4X8-32 UNC  $\nabla$  .375in[9.53mm]

500 slpm to 1500 slpm approximate shipping weight: 3.5 lb

**MS-Series:**

0 – 2000 slpm

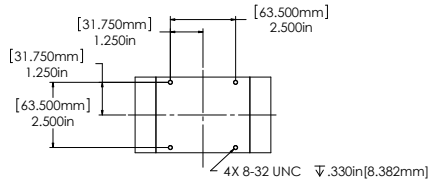
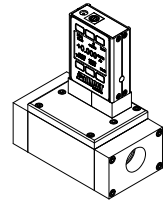
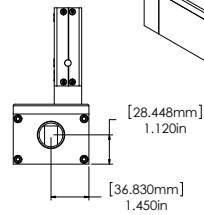
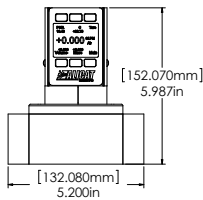
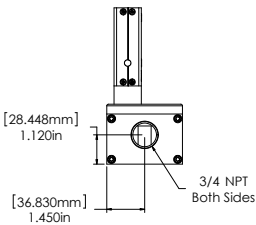
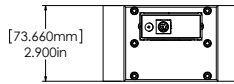

4X 8-32 UNC  $\nabla$  .330in[8.382mm]

2000 slpm approximate shipping weight: 4.5 lb

**MS-Series:**  
0 – 3000 slpm

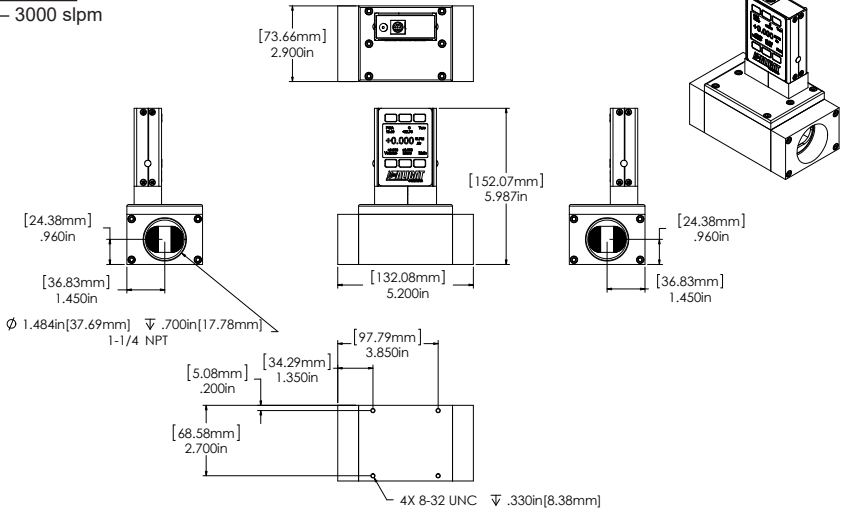

3000 slpm approximate shipping weight: 4.5 lb

**MS-Series:**  
0 – 4000 slpm

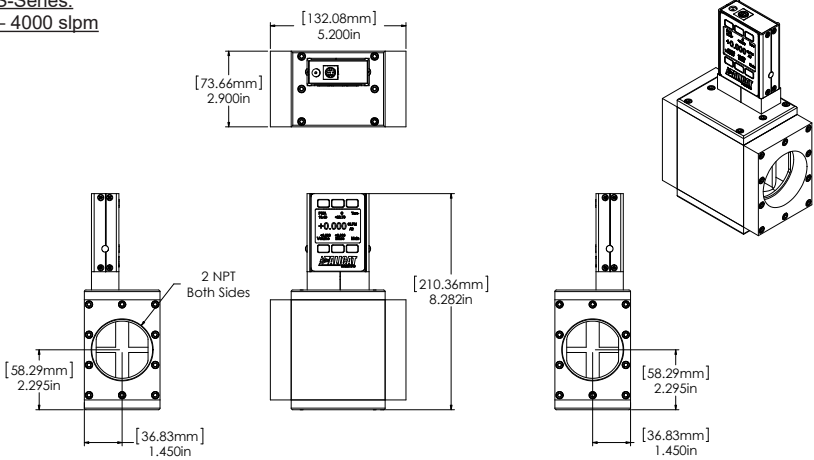

4000 slpm approximate shipping weight: 12.2 lb

# Technical Data for Alicat MQ Mass Flow Meters

## 0 to 0.5 sccm Full Scale through 0 to 3000 slpm Full Scale

Alicat MQ units are for high pressure applications. The flow rate is dependent on the pressure in that lower pressures will yield lower flow rates. The Q series should only be ordered after consulting Alicat. MQ units are calibrated for operation at high pressure. Optimal performance is achieved at higher operating pressures.

*Maximum Operating Pressure – 320 psia*

### Standard Operating Specifications (Contact Alicat for available options)

Performance	MQ-Series Mass Flow Meter
Accuracy at calibration conditions after tare	± 2% of Full Scale
Repeatability	± 0.2% Full Scale
Zero Shift and Span Shift	0.02% Full Scale / °Celsius / Atm
Operating Range / Turndown Ratio	2% to 100% Full Scale / 50:1 Turndown
Maximum Measurable Flow Rate	up to 128% Full Scale (Gas Dependent)
Typical Response Time	10 ms (Adjustable)
Warm-up Time	< 1 Second

Operating Conditions	MQ-Series Mass Flow Meter
Mass Reference Conditions (STP)	25°C & 14.696 psia (standard — others available on request)
Operating Temperature	-10 to +60 °Celsius
Humidity Range (Non-Condensing)	0 to 100%
Maximum Internal Pressure (Static)	320 psia
Maximum Operating Pressure	320 psia
Proof Pressure	400 psig
Mounting Attitude Sensitivity	None
Ingress Protection	IP40
Wetted Materials	303 & 302 Stainless Steel, Viton®, Heat Cured Silicone Rubber, Glass Reinforced Polyphenylene Sulfide, Heat Cured Epoxy, Aluminum, Gold, Silicon, Glass. If your application demands a different material, please contact Alicat.

Communications / Power	MQ-Series Mass Flow Meter
Monochrome LCD or Color TFT Display with integrated touchpad	Simultaneously displays Mass Flow, Volumetric Flow, Pressure and Temperature
Digital Communications Options <sup>1</sup>	RS-232 Serial, RS-485 Serial, DeviceNet, EtherCAT, EtherNet/IP, Modbus RTU, Modbus TCP/IP, PROFIBUS
Analog Signal <sup>2</sup> Options	0-5 Vdc / 1-5 Vdc / 0-10 Vdc / 4-20 mA
Optional Secondary Analog Output Signal <sup>2</sup>	0-5 Vdc / 1-5 Vdc / 0-10 Vdc / 4-20 mA
Electrical Connection Options	8 Pin Mini-DIN / 9-pin D-sub (DB9) / 15-pin D-sub (DB15) / 6 pin locking / 8pin M12
Supply Voltage	7 to 30 Vdc (15-30 Vdc for 4-20 mA outputs)
Supply Current	0.040 Amp (+ output current on 4-20 mA)
<sup>1</sup> The <b>Digital Output Signal</b> communicates Mass Flow, Volumetric Flow, Pressure and Temperature <sup>2</sup> The <b>Analog Output Signal</b> and <b>Optional Secondary Analog Output Signal</b> communicate your choice of Mass Flow, Volumetric Flow, Pressure or Temperature	

### Range Specific Specifications

Full Scale Flow Mass Meter	Pressure Drop at FS Flow (psid) venting to atmosphere	Mechanical Dimensions	Process Connections <sup>1</sup>
0.5 sccm to 1 sccm	1.0	4.4"H x 2.4"W x 1.1"D	M-5 (10-32) Female Thread <sup>2</sup>
2 sccm to 50 sccm	1.0		
100 sccm to 20 slpm	1.0	4.6"H x 2.4"W x 1.1"D	1/8" NPT Female
50 slpm	2.0	5.1"H x 4.0"W x 1.6"D	1/4" NPT Female
100 slpm	2.5		
250 slpm	2.1	5.7"H x 4.0"W x 1.6"D	1/2" NPT Female
500 slpm	4.0	5.7"H x 4.0"W x 1.6"D	3/4" NPT Female (A 1-1/4" NPT Female optional process connection is available for 2000 slpm meters.)
1000 slpm	6.0		
1500 slpm	9.0		
2000 slpm	5.0	6.0"H x 5.2"W x 2.9"D	
3000 slpm	7.1	6.0"H x 5.2"W x 2.9"D	1-1/4" NPT Female
<sup>1</sup> Compatible with Swagelok® tube, Parker®, face seal, push connect and compression adapter fittings. VCR and SAE connections upon request. <sup>2</sup> Shipped with M-5 (10-32) Male Buna-N O-ring face seal to 1/8" Female NPT fittings.			

**MQ-Series**

- 0 – 0.5 sccm
- 0 – 1 sccm
- 0 – 2 sccm
- 0 – 5 sccm
- 0 – 10 sccm
- 0 – 20 sccm
- 0 – 50 sccm

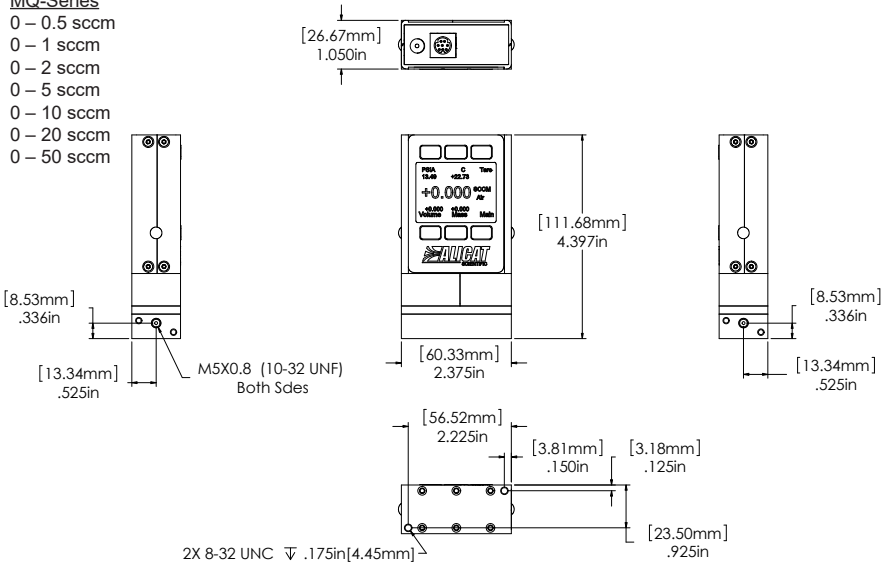

0.5 sccm to 50 sccm approximate shipping weight: 0.8lb

**MQ-Series**

- 0 – 100 sccm
- 0 – 200 sccm
- 0 – 500 sccm
- 0 – 1 slpm
- 0 – 2 slpm
- 0 – 5 slpm
- 0 – 10 slpm
- 0 – 20 slpm

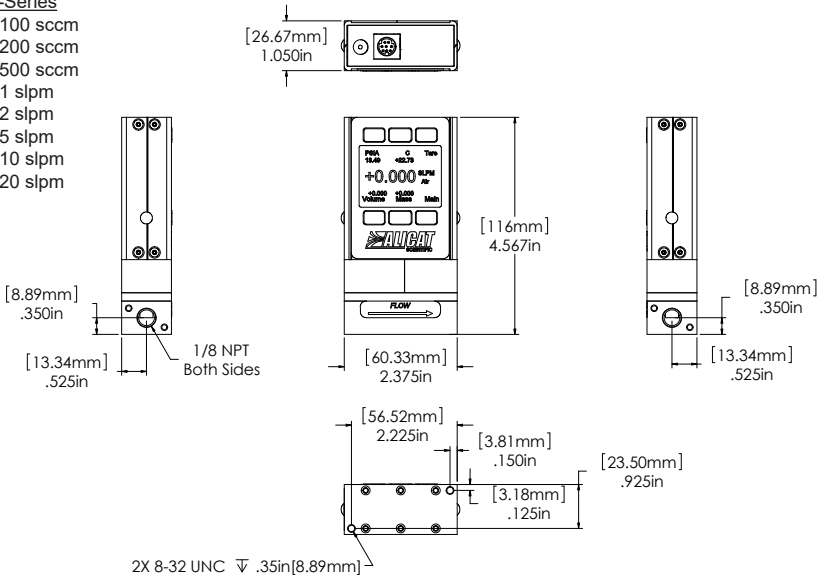

100 sccm to 20 slpm approximate shipping weight: 1.0 lb



**MQ-Series**

0 – 50 slpm  
0 – 100 slpm

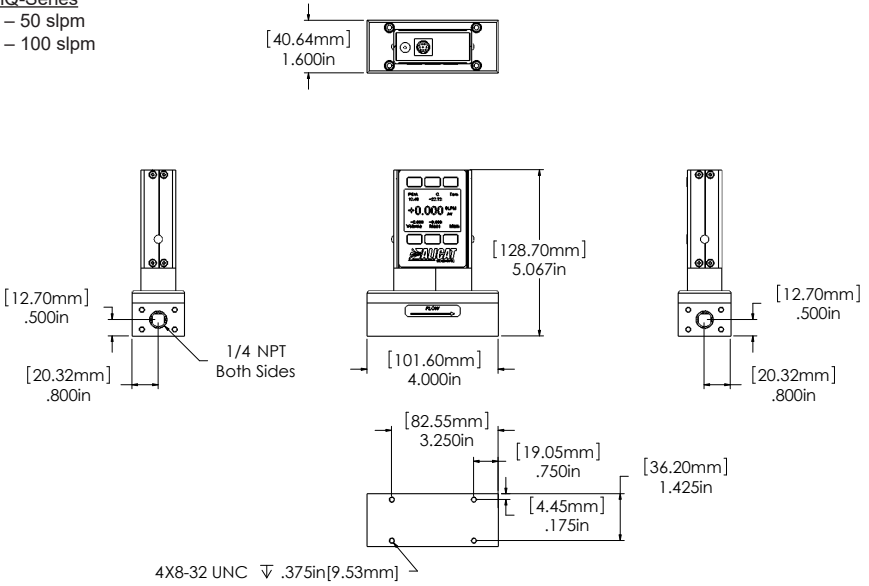

50 slpm to 100 slpm approximate shipping weight: 2.4 lb.

**MQ-Series**

0 – 250 slpm

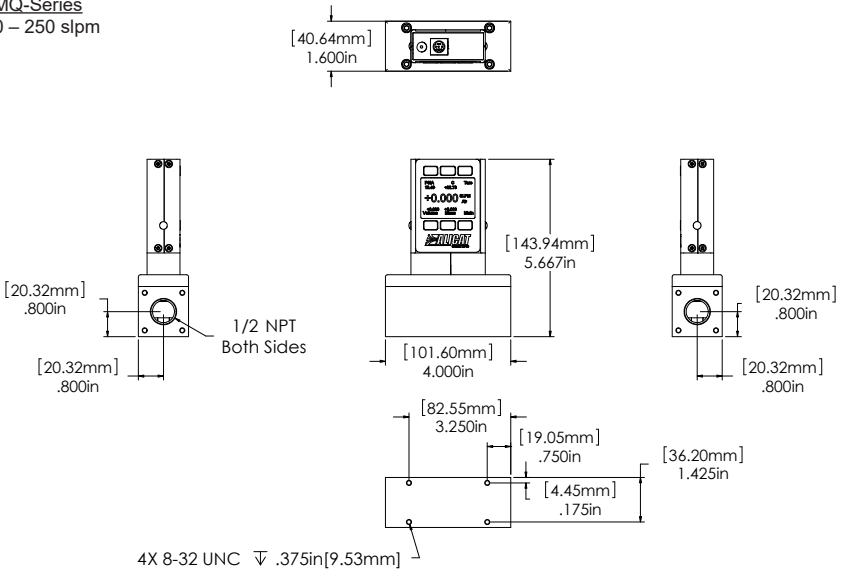

250 slpm approximate shipping weight: 3.2 lb.

**MQ-Series**

- 0 – 500 slpm
- 0 – 1000 slpm
- 0 – 1500 slpm

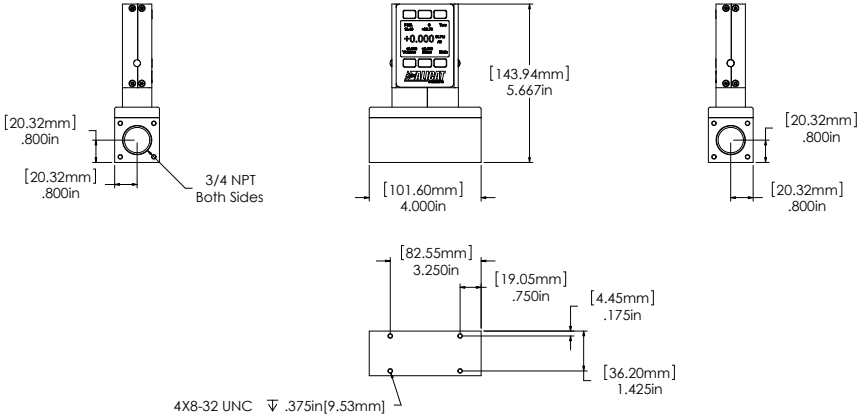
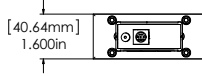

500 slpm to 1500 slpm approximate shipping weight: 3.5 lb

**MQ-Series**

- 0 – 2000 slpm

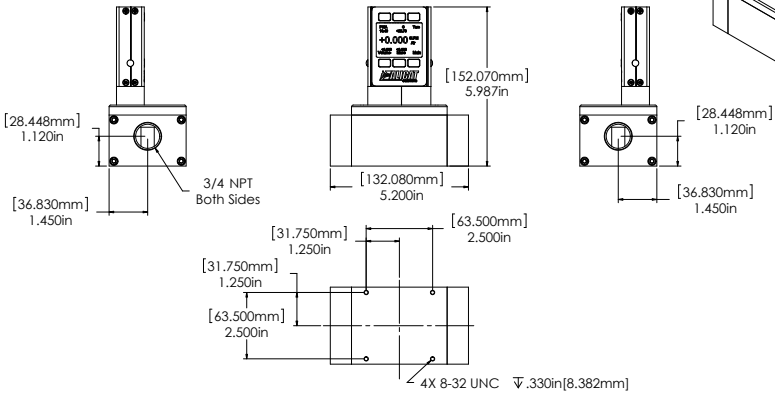
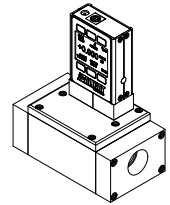
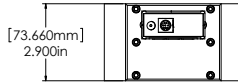

2000 slpm approximate shipping weight: 4.5 lb

**MQ-Series**  
0 – 3000 slpm

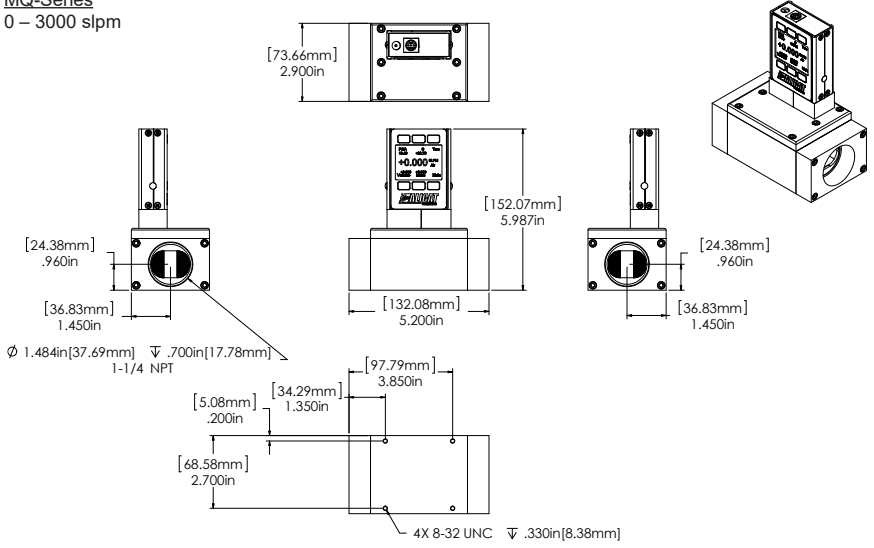

3000 slpm approximate shipping weight: 4.5 lb

# Technical Data for Alicat MB-Series Portable Mass Flow Meters

## 0 to 0.5 sccm Full Scale through 0 to 5000 slpm Full Scale

### Standard Operating Specifications (Contact Alicat for available options)

Performance	MB-Series Mass Flow Meter
Accuracy at calibration conditions after tare	± (0.8% of Reading + 0.2% of Full Scale)
High Accuracy at calibration conditions after tare	± (0.4% of Reading + 0.2% of Full Scale) High Accuracy option not available for units ranged under 5 sccm or over 500 slpm.
Accuracy for Bidirectional Meters at calibration conditions after tare	± (0.8% of reading + 0.2% of total span from positive full scale to negative full scale)
Repeatability	± 0.2% Full Scale
Zero Shift and Span Shift	0.02% Full Scale / °Celsius / Atm
Operating Range / Turndown Ratio	0.5% to 100% Full Scale / 200:1 Turndown
Maximum Measurable Flow Rate	up to 128% Full Scale (Gas Dependent)
Typical Response Time	10 ms (Adjustable)
Warm-up Time	< 1 Second
Battery Life	Monochrome display at 10 Contrast: 18 hours / Color display at 10 Brightness: 5 hours
Recharge Time	3.5 hours with 2A USB supply and device turned off

Operating Conditions	MB-Series Mass Flow Meter
Mass Reference Conditions (STP)	25°C & 14.696 psia (standard — others available on request)
Operating Temperature	-10 to +60 °Celsius
Humidity Range (Non-Condensing)	0 to 100%
Maximum Internal Pressure (Static)	145 psig
Maximum Allowable Instantaneous Differential Pressure Across Device (Inlet to Outlet)	75 psid
Proof Pressure	175 psig
Mounting Attitude Sensitivity	None
Ingress Protection	IP40
Wetted Materials	303 & 302 Stainless Steel, Viton®, Heat Cured Silicone Rubber, Glass Reinforced Polyphenylene Sulfide, Heat Cured Epoxy, Aluminum, Gold, Silicon, Glass. If your application demands a different material, please contact Alicat.

Communications / Power	MB-Series Mass Flow Meter
Monochrome LCD or Color TFT Display with integrated touchpad	Simultaneously displays Mass Flow, Volumetric Flow, Pressure and Temperature
Digital Output Signal <sup>1</sup> Options	RS-232 Serial
Analog Signal <sup>2</sup> Options	0-5 Vdc / 1-5 Vdc / 4-20 mA (Receiver resistance must be below 250Ω)
Optional Secondary Analog Output Signal <sup>2</sup>	0-5 Vdc / 1-5 Vdc / 4-20 mA (Receiver resistance must be below 250Ω)
Electrical Connection Options	Micro-USB-B / 8 Pin Mini-DIN
Supply Voltage	+5 Vdc (Micro-USB-B) / +7 to +30 Vdc (8 Pin Mini-DIN)

1. The **Digital Output Signal** communicates Mass Flow, Volumetric Flow, Pressure and Temperature

2. The **Analog Output Signal** and **Optional Secondary Analog Output Signal** communicate your choice of Mass Flow, Volumetric Flow, Pressure or Temperature

### Range Specific Specifications

Full Scale Flow Mass Meter	Pressure Drop at FS Flow (psid) venting to atmosphere <sup>1</sup>	Mechanical Dimensions	Process Connections <sup>2</sup>
0.5 sccm to 1 sccm	1.0	6.4"H x 2.4"W x 1.1"D	M-5 (10-32) Female Thread <sup>3</sup>
2 sccm to 50 sccm	1.0		
100 sccm to 20 slpm	1.0	6.7"H x 2.4"W x 1.1"D	1/8" NPT Female
50 slpm	2.0	7.0"H x 4.0"W x 1.6"D	1/4" NPT Female
100 slpm	2.5		
250 slpm	2.1	7.6"H x 4.0"W x 1.6"D	1/2" NPT Female
500 slpm	4.0	7.6"H x 4.0"W x 1.6"D	3/4" NPT Female (A 1-1/4" NPT Female optional process connection is available for 2000 slpm meters.)
1000 slpm	6.0		
1500 slpm	9.0		
2000 slpm	5.0	7.9"H x 5.2"W x 2.9"D	2" NPT Female
3000 slpm	7.1	7.9"H x 5.2"W x 2.9"D	1-1/4" NPT Female
4000 slpm	2.7	10.2"H x 5.2"W x 2.9"D	2" NPT Female
5000 slpm	3.4	8.9"H x 5.2"W x 3.9"W	2" NPT Female

1. Lower Pressure Drops Available, please see our **WHISPER-Series** mass flow controllers at [www.alicat.com/whisper](http://www.alicat.com/whisper).

2. Compatible with Swagelok® tube, Parker®, face seal, push connect and compression adapter fittings. VCR and SAE connections upon request.

3. Shipped with M-5 (10-32) Male Buna-N O-ring face seal to 1/8" Female NPT fittings.

**MB-Series:**

- 0 – 0.5 sccm
- 0 – 1 sccm
- 0 – 2 sccm
- 0 – 5 sccm
- 0 – 10 sccm
- 0 – 20 sccm
- 0 – 50 sccm

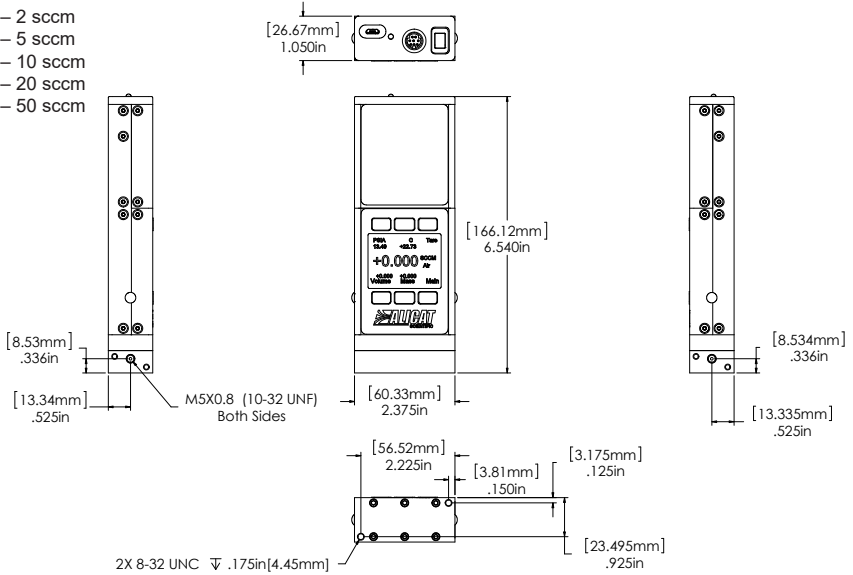

0.5 sccm to 50 sccm approximate shipping weight: 0.8 lb

**MB-Series:**

- 0 – 100 sccm
- 0 – 200 sccm
- 0 – 500 sccm
- 0 – 1 slpm
- 0 – 2 slpm
- 0 – 5 slpm
- 0 – 10 slpm
- 0 – 20 slpm

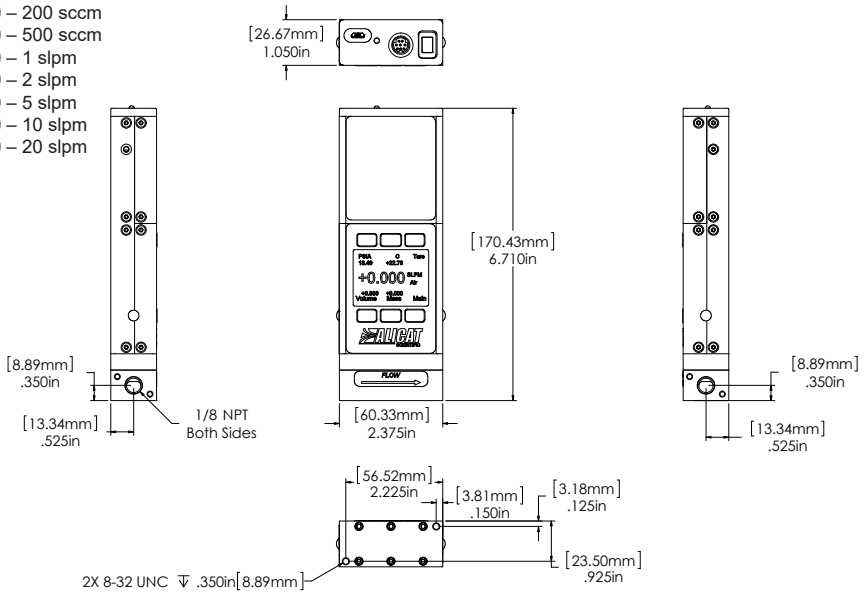

100 sccm to 20 slpm approximate shipping weight: 1.0 lb

**MB-Series:**

0 – 50 slpm

0 – 100 slpm

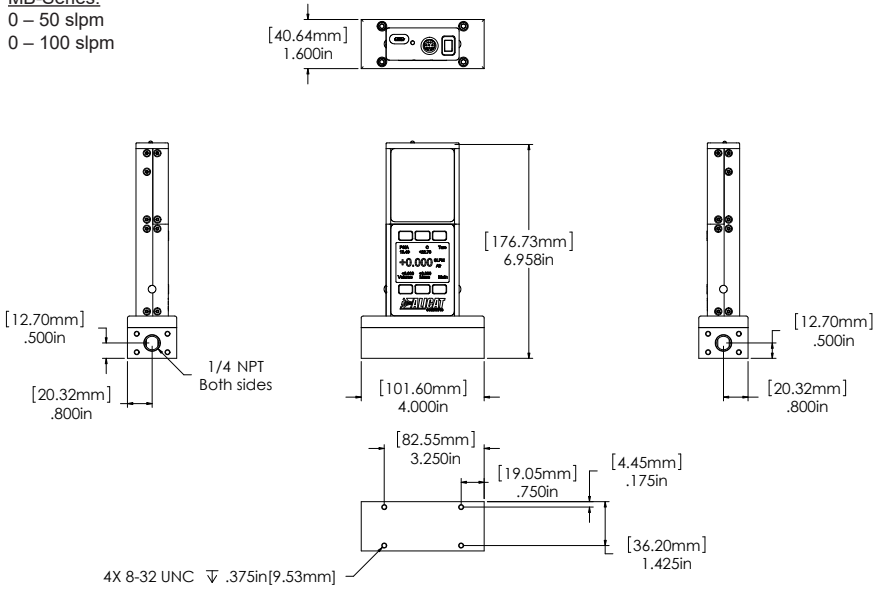

50 slpm to 100 slpm approximate shipping weight: 2.4 lb.

**MB-Series:**

0 – 250 slpm

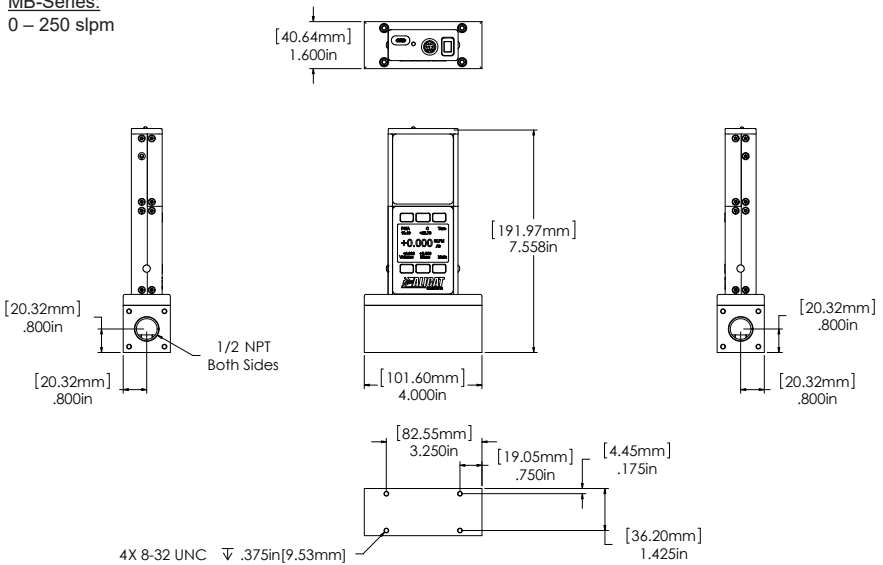

250 slpm approximate shipping weight: 3.2 lb.

**MB-Series:**

- 0 – 500 slpm
- 0 – 1000 slpm
- 0 – 1500 slpm

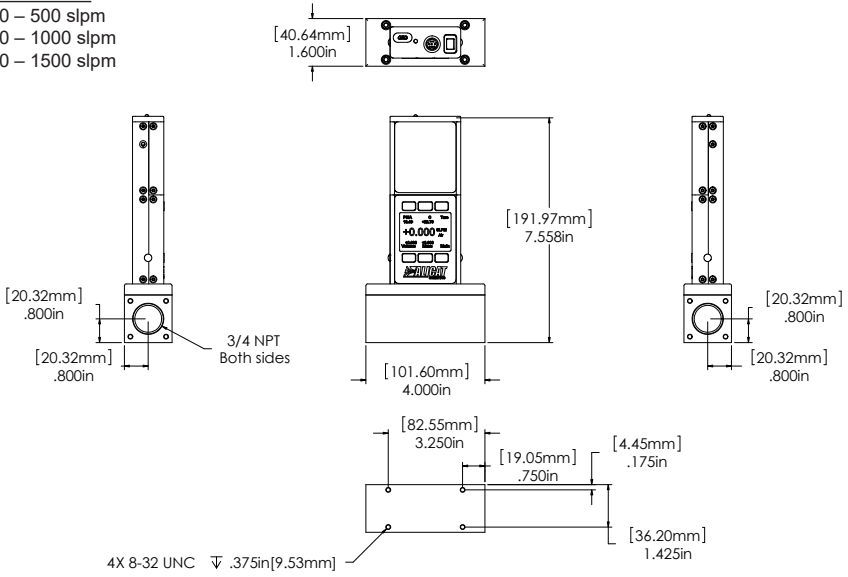

500 slpm to 1500 slpm approximate shipping weight: 3.5 lb

**MB-Series:**

- 0 – 2000 slpm

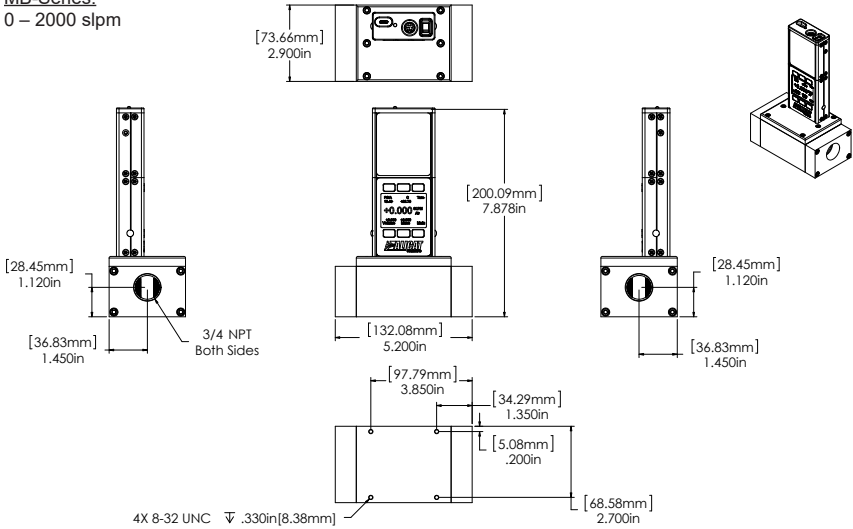

2000 slpm approximate shipping weight: 4.5 lb

**MB-Series:**

0 – 3000 slpm

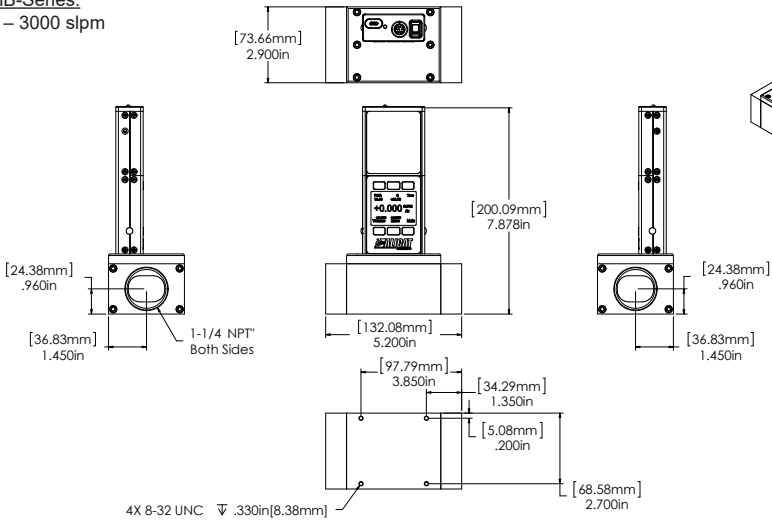

3000 slpm approximate shipping weight: 4.5 lb

**MB-Series:**

0 – 4000 slpm

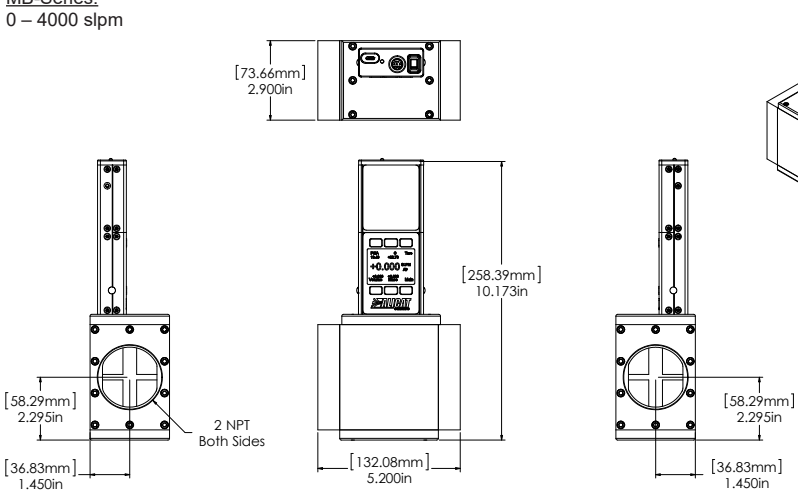

4000 slpm approximate shipping weight: 12.2 lb



MB-Series:  
0 – 5000 slpm

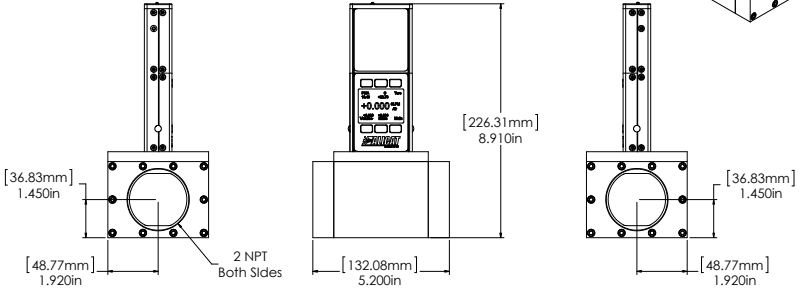
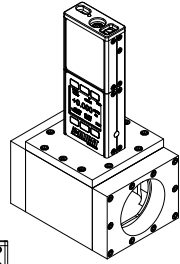
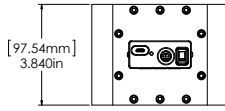

5000 slpm approximate shipping weight: 14.0lb

# Technical Data for Alicat Whisper Portable Mass Flow Meters

## 0 to 0.5 sccm Full Scale through 0 to 500 slpm Full Scale

### Standard Operating Specifications (Contact Alicat for available options)

Performance	Whisper Mass Flow Meter
Accuracy at calibration conditions after tare	± (0.8% of Reading + 0.2% of Full Scale)
High Accuracy at calibration conditions after tare	± (0.4% of Reading + 0.2% of Full Scale) High Accuracy option not available for units ranged under 5 sccm or over 500 slpm.
Accuracy for Bidirectional Meters at calibration conditions after tare	± (0.8% of reading + 0.2% of total span from positive full scale to negative full scale)
Repeatability	± 0.2% Full Scale
Zero Shift and Span Shift	0.02% Full Scale / °Celsius / Atm
Operating Range / Turndown Ratio	0.5% to 100% Full Scale / 200:1 Turndown
Maximum Measurable Flow Rate	up to 128% Full Scale (Gas Dependent)
Typical Response Time	10 ms (Adjustable)
Warm-up Time	< 1 Second
Battery Life	Monochrome display at 10 Contrast: 18 hours / Color display at 10 Brightness: 5 hours
Recharge Time	3.5 hours with 2A USB supply and device turned off

Operating Conditions	Whisper Mass Flow Meter
Mass Reference Conditions (STP)	25°C & 14.696 psia (standard — others available on request)
Operating Temperature	-10 to +60 °Celsius
Humidity Range (Non-Condensing)	0 to 100%
Maximum Internal Pressure (Static)	145 psig
Maximum Allowable Instantaneous Differential Pressure Across Device (Inlet to Outlet)	75 psid
Proof Pressure	175 psig
Mounting Attitude Sensitivity	None
Ingress Protection	IP40
Wetted Materials	303 & 302 Stainless Steel, Viton®, Heat Cured Silicone Rubber, Glass Reinforced Polyphenylene Sulfide, Heat Cured Epoxy, Aluminum, Gold, Silicon, Glass. If your application demands a different material, please contact Alicat.

Communications / Power	Whisper Mass Flow Meter
Monochrome LCD or Color TFT Display with integrated touchpad	Simultaneously displays Mass Flow, Volumetric Flow, Pressure and Temperature
Digital Communications Options <sup>1</sup>	RS-232 Serial
Analog Signal <sup>2</sup> Options	0-5 Vdc / 1-5 Vdc / 4-20 mA (Receiver resistance must be below 250Ω)
Optional Secondary Analog Output Signal <sup>2</sup>	0-5 Vdc / 1-5 Vdc / 4-20 mA (Receiver resistance must be below 250Ω)
Electrical Connection Options	Micro-USB-B / 8 Pin Mini-DIN
Supply Voltage	+5 Vdc (Micro-USB-B) / +7 to +30 Vdc (8 Pin Mini-DIN)
1. The <b>Digital Output Signal</b> communicates Mass Flow, Volumetric Flow, Pressure and Temperature	
2. The <b>Analog Output Signal</b> and <b>Optional Secondary Analog Output Signal</b> communicate your choice of Mass Flow, Volumetric Flow, Pressure or Temperature	

### Range Specific Specifications

Full Scale Flow Mass Meter	Pressure Drop at FS Flow (psid) venting to atmosphere	Mechanical Dimensions	Process Connections <sup>1</sup>
0.5 sccm to 2 sccm	0.06	6.4"H x 2.4"W x 1.1"D	M-5 (10-32) Female Thread <sup>2</sup>
5 sccm to 20 sccm	0.07		
50 sccm	0.07	6.8"H x 2.4"W x 1.1"D	1/8" NPT Female
100 sccm to 200 sccm	0.06		
500 sccm	0.07		
1 slpm to 5 slpm	0.07	7.0"H x 2.7"W x 1.1"D	1/4" NPT Female
10 slpm	0.08		
20 slpm	0.25		
40 slpm	0.12	7.7"H x 4.0"W x 1.6"D	1/2" NPT Female
50 slpm	0.14		
100 slpm	0.24	7.7"H x 4.0"W x 1.6"D	3/4" NPT Female
250 slpm	0.60		
500 slpm	0.39	8.0"H x 5.2"W x 2.9"D	3/4" NPT Female

1. Compatible with Swagelok® tube, Parker®, face seal, push connect and compression adapter fittings. VCR and SAE connections upon request.

2. Shipped with M-5 (10-32) Male Buna-N O-ring face seal to 1/8" Female NPT fittings.

# Optional Pinouts

## Locking Industrial Connector Pinouts

If your Alicat Instrument was ordered with a Six Pin Locking Industrial connection, please be sure to reference the following pinout diagram.

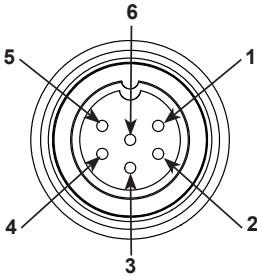

**Male Connector: Cable**

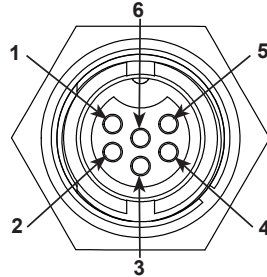

**Female Connector: Device**

Pin	Function
1	Power In ( + )
2	RS-232TX / RS-485(+)
3	RS-232RX / RS-485(-)
4	Meters/Gauges = Remote Tare (Ground to Tare) Controllers = Analog Setpoint Input
5	Ground (common for power, communications and signals)
6	Signal Out (Voltage or Current as ordered)



The above pinout is applicable to all the flow meters and controllers ordered with the industrial connector. The availability of different output signals depends on the flow meter options ordered.

## 9 pin D-Sub Common Pinouts

If your instrument was ordered with a DB9 connection, be sure to check the calibration label on the device or the calibration data sheet and reference the appropriate pinout diagram.

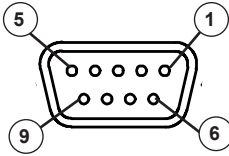

Female Connector Front View

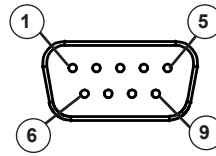

Male Connector Front View

### Common Pinouts

Pin	DB9 (Female) DB9M (Male)	DB9A / DB9K	DB9R	DB9T	DB9U
1	Current Out	NC	TX (+)	TX (+)	RX (-)
2	Analog Out 2	Analog Out	Analog Out	Analog Out	Analog Out
3	RX (-)	Power In	Analog In	Power In	Power In
4	Analog In	Ground	Ground	Ground	Ground
5	TX (+)	TX (+)	NC	NC	NC
6	Analog Out	Analog In	RX (-)	Analog In	Analog In
7	Power In	Ground	Power In	Ground	Ground
8	Ground	Ground	Ground	Ground	Ground
9	Ground	RX (-)	Ground	RX (-)	TX (+)

**Current Out** = Not Connected or optional 4-20 mA analog output signal

**Analog In** = setpoint for controllers or remote tare function for meters

**Analog Out** = 0-5 Vdc Output Signal (or 0-10 Vdc optional)

**Analog Out 2** = 5.12Vdc or Optional Secondary Analog Output

**TX (+)** = Serial RS-232TX or RS-485(+)

**RX (-)** = Serial RS-232RX or RS-485(-)

**NC** = Not Connected

**Power In** = (+Vdc)

**Ground** = Common for power, digital communications, analog signals and alarms

### Additional Pinouts

Pin	DB9B	DB9G	DB9H	DB9I	DB9N
1	Analog Out 2	RX (-)	TX (+)	NC	Power In
2	Analog Out	Analog Out	Analog Out	Analog Out	Analog In
3	Power In	Ground	Analog In	Power In	Analog Out
4	Ground	Power In	RX (-)	Ground	NC
5	Ground	Ground	Analog Out 2	NC	Ground
6	Analog In	TX (+)	NC	Analog In	Ground
7	Ground	Analog In	Power In	Ground	RX (-)
8	TX (+)	Current Out	Ground	RX (-)	TX (+)
9	RX (-)	Ground	Ground	TX (+)	NC5

Individual pinouts available at [www.alicat.com/pinout](http://www.alicat.com/pinout)



Due to variance in cable manufacturing, please identify proper wiring/pins via continuity check & color when using blunt cut multi-strand cables.

## 15 pin D-Sub Common Pinouts

If your instrument was ordered with a DB15 connection, be sure to check the calibration label on the device or the calibration data sheet and reference the appropriate pinout diagram.

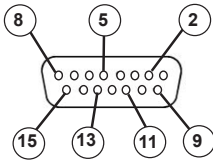

Female Connector Front View

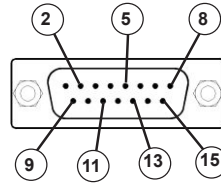

Male Connector Front View

Pin	DB15	DB15A	DB15B	DB15H	DB15K	DB15O	DB15S
1	Ground	Ground	Ground	NC	NC	Ground	Ground
2	Analog Out	Analog Out	Analog Out	RX (-)	Analog Out	NC	Analog Out
3	Ground	Analog In	NC	NC	NC	NC	NC
4	NC	Ground	NC	NC	NC	Analog Out	NC
5	Power In	Ground	Power In	Ground	Ground	Power In	Ground
6	NC	Ground	NC	Analog Out	NC	NC	NC
7	NC	Power In	NC	Ground	Power In	Analog In	NC
8	Analog In	TX (+)	Analog In	NC	Analog In	NC <sup>5</sup>	Analog In
9	Ground	Ground	Ground	NC	AnalogOut2	Ground	Ground
10	Ground	NC	Ground	AnalogOut2	NC	Ground	Ground
11	AnalogOut2	NC	AnalogOut2	Power In	Ground	AnalogOut2	AnalogOut2
12	NC	AnalogOut2	NC	Ground	Ground	NC	RX (-)
13	RX (-)	NC	NC	NC	RX (-)	NC	Power In
14	Ground	NC	RX (-)	Analog In	TX (+)	RX (-)	TX (+)
15	TX (+)	RX (-)	TX (+)	TX (+)	Ground	TX (+)	Ground

**Analog In** = setpoint for controllers or remote tare function for meters

**Analog Out** = 0-5 Vdc Output Signal (or 0-10 Vdc optional)

**Analog Out 2** = 5.12Vdc or Optional Secondary Analog Output

TX (+) = Serial RS-232TX or RS-485(+)

RX (-) = Serial RS-232RX or RS-485(-)

NC = Not Connected

Power In = (+Vdc)

Ground = Common for power, digital communications, analog signals and alarms

Individual pinouts available at [www.alicat.com/pinout](http://www.alicat.com/pinout)



Due to variance in cable manufacturing, please identify proper wiring/pins via continuity check & color when using blunt cut multi-strand cables.

## High Density 15 pin D-Sub Common Pinouts

If your instrument was ordered with a High Density DB15 connection, be sure to check the calibration label on the device or the calibration data sheet and reference the appropriate pinout diagram.

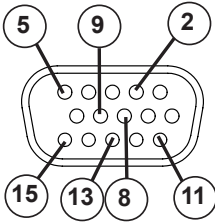

Female Connector Front View

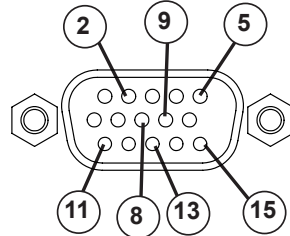

Male Connector Front View

Pin	DB15HD	DB15HDS
1	Ground	Ground
2	Analog Out	Analog Out
3	Ground	Analog In
4	NC	Ground
5	Power In	Ground
6	NC	Ground
7	NC	Power In
8	Analog In	TX (+)
9	Ground	Ground
10	Ground	NC
11	Analog Out 2	NC
12	NC	Analog Out 2
13	RX (-)	NC
14	Ground	NC
15	TX (+)	RX (-)

**Analog In** = setpoint for controllers or remote tare function for meters

**Analog Out** = 0-5 Vdc Output Signal (or 0-10 Vdc optional)

**Analog Out 2** = 5.12Vdc or Optional Secondary Analog Output

TX (+) = Serial RS-232TX or RS-485(+)

RX (-) = Serial RS-232RX or RS-485(-)

NC = Not Connected

Power In = (+Vdc)

Ground = Common for power, digital communications, analog signals and alarms

Individual pinouts available at [www.licat.com/pinout](http://www.licat.com/pinout)



Due to variance in cable manufacturing, please identify proper wiring/pins via continuity check & color when using blunt cut multi-strand cables.

# Additional Information for Alicat CSA and ATEX Approved Devices



EEx nA IIC T4

Class I, Div. 2 Group A, B, C and D T4

24 Vdc, 0.800A max

Class I, Zone 2 AEx nA IIC T4



**WARNINGS:**

**EXPLOSION HAZARD** – DO NOT DISCONNECT WHILE CIRCUIT IS LIVE UNLESS AREA IS KNOWN TO BE NON-HAZARDOUS.

**EXPLOSION HAZARD** – SUBSTITUTION OF COMPONENTS MAY IMPAIR SUITABILITY FOR CLASS I, DIVISION 2.

Alicat CSA / ATEX approved devices are equipped with either a locking six pin industrial connector (IC), locking D-sub 15 pin connector (DB15) or locking D-sub 9 pin connector (DB9). Please see page 83 to page 86 for the correct power and signal connections for each type of connector.

**See the following page for special conditions regarding the use of these units!**

**USE of Alicat instruments (L, LC, LCR, M, MW, MS, MC, MCW, MCS, MCR, MCRW, MCRS, MCD, P, PS, PC, PCD, PCS, PCR and PCRS product families) in Class 1 Division 2 applications.**



CSA certifies the use of this product for general use as well as use in hazardous locations as defined by Class 1 Division 2 Group A, B, C and D T4.

**CSA certification is indicated by the product label as shown below and not by the statements in this, or any accompanying documentation.**

**Special Conditions:**

To comply with CSA certification the following information is included in the product literature:

- When equipment is properly labeled, it is suitable in Class I, Division 2, Group A, B, C and D, T4
  - Tamb. -40°C to +50°C
- Electrical Rating 24Vdc, 0.800A max
- Instruments shall be powered by a CSA certified, UL listed, Class II external power supply suitable for the application
- Instruments shall be housed in an enclosure with a minimum IP54 rating or location providing equivalent protection
- Instrument's final approval shall be provided by the local authority having jurisdiction

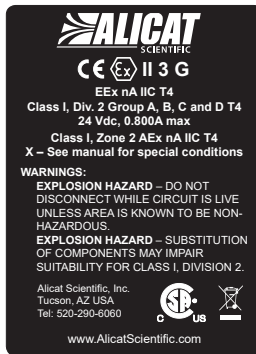

**USE of Alicat instruments (L, LC, LCR, M, MW, MS, MC, MCD, MCW, MCS, MCR, MCRW, MCRS, P, PS, PC, PCD, PCS, PCR and PCRS product families) in applications requiring ATEX Class 1 Zone 2 Certification.**



Properly labeled Alicat instruments comply to the following ATEX standard:

 II 3 G EEx nA IIC T4 (-40°C ≤ Ta ≤ +50°C)

The examination certificate was issued by the CSA in accordance with accepted practices and procedures. This confirms compliance with the European ATEX Directive or Group II Category 3G equipment.

**ATEX certification is indicated by the product label as shown above and not by the statements in this, or any accompanying documentation.**

**Special Conditions:**

- Properly labeled equipment is only certified for use in ambient temperatures in the range of -40°C to +50°C only
- Electrical Rating 24Vdc, 0.800A max
- Instruments shall be powered by a CSA certified, UL listed, Class II external power supply suitable for the application
- Instruments shall be housed in an enclosure with a minimum IP54 rating or location providing equivalent protection
- Instrument's final approval shall be provided by the local authority having jurisdiction



# Limited Lifetime Warranty

Alicat Scientific, Inc. warrants to the original purchaser (hereinafter referred to as "Buyer") that instruments manufactured by Alicat Scientific (hereinafter referred to as "Product") shall be free from defects in materials and workmanship for the life of the Products.

Under this warranty, the Products will be repaired or replaced at manufacturer's option, without charge for parts or labor when the Product is carried or shipped prepaid to the factory together with proof of purchase. The foregoing shall constitute the exclusive and sole remedy in lieu of other remedies of the Buyer for any breach by Alicat Scientific of this warranty to the maximum extent permitted by law.

This warranty does not apply to any Product which has not been installed or used in accordance with the Product operation and installation specifications provided to Buyer verbally or in writing by Alicat Scientific for the proper and normal use of the Product.

Buyer agrees hereunder that Alicat reserves the right to void any warranty, written or implied, if upon Alicat's examination of Product shall disclose to Alicat's satisfaction that the Product failure was due solely, or in part, to accident, misuse, neglect, abuse, alteration, improper installation, unauthorized repair or improper testing by Buyer or agent of Buyer.

Alicat Scientific shall not be liable under any circumstances for indirect, special, consequential, or incidental damages in connection with, or arising out of, the sale, performance, or use of the Products covered by this warranty.

Alicat Scientific does not recommend, warrant or assume responsibility for the use of the Products in life support applications or systems.

Alicat's warranties as herein above set forth shall not be enlarged, diminished or affected by, and no obligation or liability shall arise or grow out of Alicat's rendering of technical advice in connection with Buyer's order of the Products furnished hereunder.

If Product becomes obsolete, Alicat Scientific, at its own discretion, reserves the right to repair the Product with available replacement parts or upgrade the Product to a current, commercially available version of the original Product. Should upgrading the Product be deemed necessary by Alicat, Buyer hereby agrees to pay an upgrade fee equal to seventy percent of the retail value of the replacement Product. Alicat Scientific hereunder makes no claim that replacement Products will look, function or operate in the same or similar manner as the original product.

When a Product is returned to Alicat Scientific for recalibration this service is considered normal preventative maintenance. Recalibration of Product shall not be treated as a warranty service unless recalibration of Product is required as the result of repairs to Product pursuant to this Warranty. Failure of Buyer to send Product to Alicat Scientific for recalibration on a yearly basis after a period of 36 months from date of manufacture will remove any and all obligations regarding repair or replacement of Product as outlined by this Warranty to Buyer from Alicat Scientific.

This Warranty is in lieu of all other relevant warranties, expressed or implied, including the implied warranty of merchantability and the implied warranty of fitness for a particular purpose, and any warranty against infringement of any patent.

Continued use or possession of Products after expiration of the applicable warranty period stated above shall be conclusive evidence that the warranty is fulfilled to the full satisfaction of Buyer.

Alicat makes no warranty as to experimental, non-standard or developmental Products.

Accessories purchased from Alicat are not covered by this warranty.

Notice: Alicat Scientific, Inc. reserves the right to make any changes and improvements to the products described in this manual at any time and without notice. This manual is copyrighted. This document may not, in whole or in part, be copied, reproduced, translated, or converted to any electronic medium or machine readable form, for commercial purposes, without prior written consent from the copyright holder.

Note: Although we provide assistance on Alicat Scientific products both personally and through our literature, it is the complete responsibility of the user to determine the suitability of any product to their application.

The product complies with the requirements of the Low Voltage Directive 2014/35/EU, the EMC Directive 2014/30/EU and the RoHS Directive 2011/65/EU and carries the CE Marking accordingly. Contact the manufacturer for more information.

## Gas Viscosity, Density and Compressibility:

#	Gas	Absolute Viscosity* 25°C	Density ** 25°C	Compressibility 25°C	
0	Air	184.8989	1.1840	0.9997	
1	Argon	226.2399	1.6339	0.9994	
2	Methane	110.7595	0.6569	0.9982	
3	Carbon Monoxide	176.4933	1.1453	0.9996	
4	Carbon Dioxide	149.3184	1.8080	0.9950	
5	Ethane	93.5412	1.2385	0.9924	
6	Hydrogen	H2	0.08235	1.0006	
7	Helium	He	0.16363	1.0005	
8	Nitrogen	N2	1.1453	0.9998	
9	Nitrous Oxide	N2O	148.4124	1.8089	0.9945
10	Neon	Ne	311.1264	0.8244	1.0005
11	Oxygen	O2	205.5021	1.3088	0.9994
12	Propane	C3H8	81.4631	1.8320	0.9838
13	normal-Butane	n-C4H10	74.0536	2.4493	0.9699
14	Acetylene	C2H2	104.4480	1.0720	0.9928
15	Ethylene	C2H4	103.1839	1.1533	0.9943
16	iso-Butane	i-C4H10	74.7846	2.4403	0.9735
17	Krypton	Kr	251.3249	3.4323	0.9979
18	Xenon	Xe	229.8483	5.3950	0.9947
19	Sulfur Hexafluoride	SF6	153.5320	6.0383	0.9887

## Flow Conversions:

SCFM	1.00 = 28.3160	SLPM	SLPM	100.00 = 3.5316	SCFM
SCFH	1.00 = 0.4719	SLPM	SLPM	100.00 = 211.9093	SCFH
SCIM	100.00 = 1.6390	SLPM	SLPM	1.00 = 61.0128	SCIM
SCIH	1000.00 = 0.2732	SLPM	SLPM	1.00 = 3660.7688	SCIH

[alicat.com](http://alicat.com)

#	Gas	Absolute Viscosity* 25°C	Density ** 25°C	Compressibility 25°C	
20	75%Ar / 25% CO2	C-25	206.9763	1.6766	0.9987
21	90%Ar / 10% CO2	C-10	218.6026	1.6509	0.9991
22	92% Ar / 8% CO2	C-8	220.1352	1.6475	0.9992
23	98% Ar / 2% CO2	C-2	224.7148	1.6373	0.9993
24	75% CO2 / 25% Ar	C-75	168.2250	1.7634	0.9966
25	75% Ar / 25% He	HE-75	231.6056	1.2660	0.9997
26	75% He / 25% Ar	HE-25	234.6860	0.5308	1.0002
27	90% He / 7.5% Ar / 2.5% CO2 Helistar® A1025	A1025	214.9760	0.3146	1.0003
28	90% Ar / 8% CO2 / 2% O2 Star29® CS	Star29	219.7934	1.6410	0.9992
29	95% Ar / 5% CH4	P-5	223.9106	1.5850	0.9993

\*In micropoise (1 Poise = gram / (cm) (sec))

\*\*Grams/Liter

Reference: NIST REFPROP 9 Database



SCIENTIFIC

7641 N Business Park Drive  
Tucson AZ 85743 USA

Phone: 888-290-6060

Fax: 520-290-0109

A HALMA COMPANY

The Fastest Flow Controller Company in the World!